

# HP Virtual Connect

## Get Connected!

Name: Matthias Aschenbrenner  
Title: Technical Consultant



# HP c-Class BladeSystem Key Technologies



# HP c-Class BladeSystem

The best-run IT infrastructure out of the box

HP innovations that solve the biggest cost drivers and change barriers of today's datacenters.



The new, modular building block of next-generation datacenters.

## Build IT Change-Ready

New! HP Virtual Connect architecture

Eliminating manual coordination across domains.

## Build IT Time-Smart

New! HP Insight Control, HP Insight Dynamics

Best savings, greatest control and most flexibility across your infrastructure.

## Build IT Cost-Savvy

New! HP Thermal Logic technology

Most energy efficiency at a rack, row and datacenter level.

# c-Class BladeSystem Interconnect Modules for Every Need

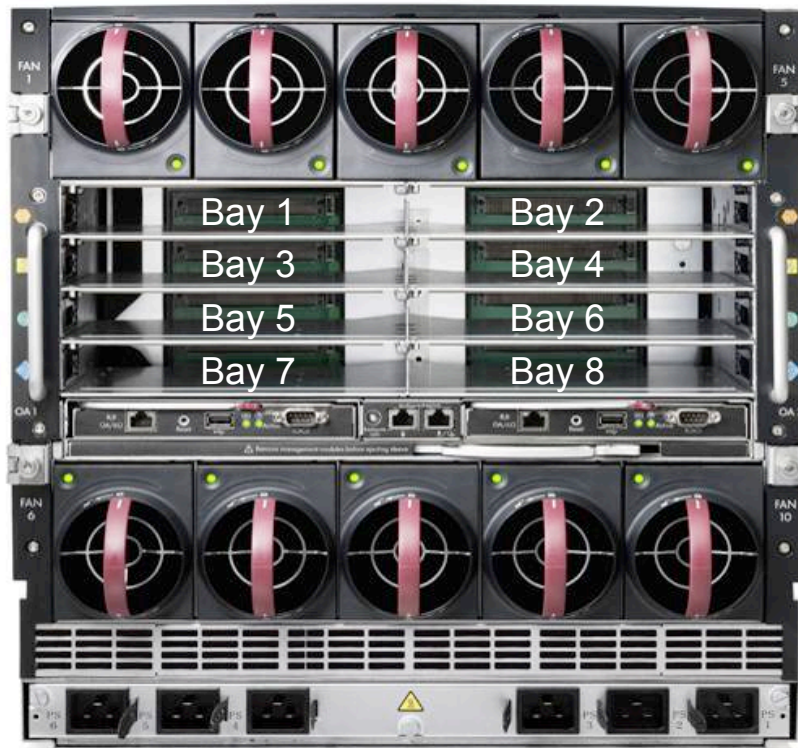

- 8 Interconnect Bays
- Two of same module side-by-side provides redundancy

## Interconnect Types

- Ethernet & FC Switches
  - Reduce cables with your favorite switch brands
- 4x DDR InfiniBand Switch
  - Highest performance IB
- Pass-Through Modules
  - When you must have a 1:1 server/network connection
- Virtual Connect
  - The Simplest, most Powerful connection to your networks

# Too many cables or too many switches and everyone gets in the act...

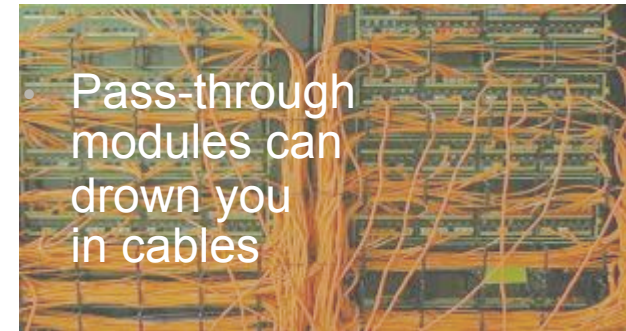
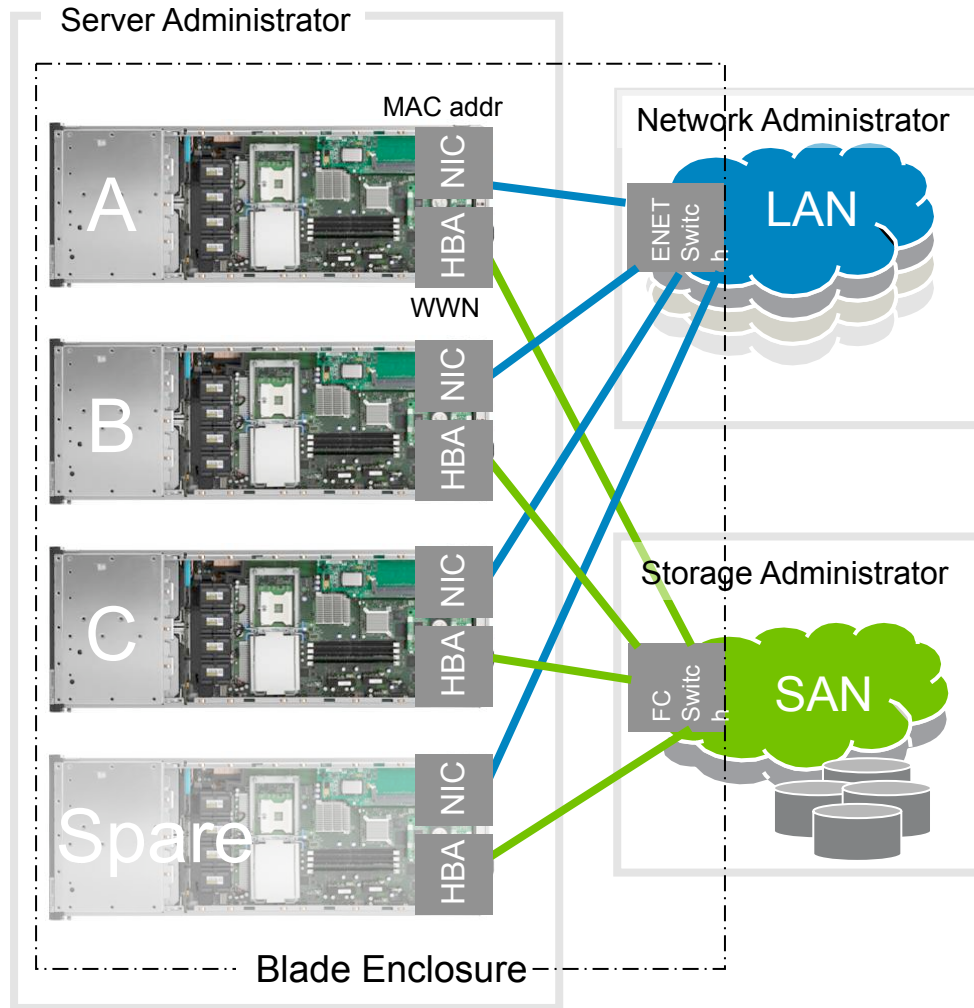

- Switches work great but can overwhelm in numbers
- LANs & SANs must follow the moving server, requiring effort from everyone and delaying resolution

# HP Virtual Connect

## Build IT Change-Ready

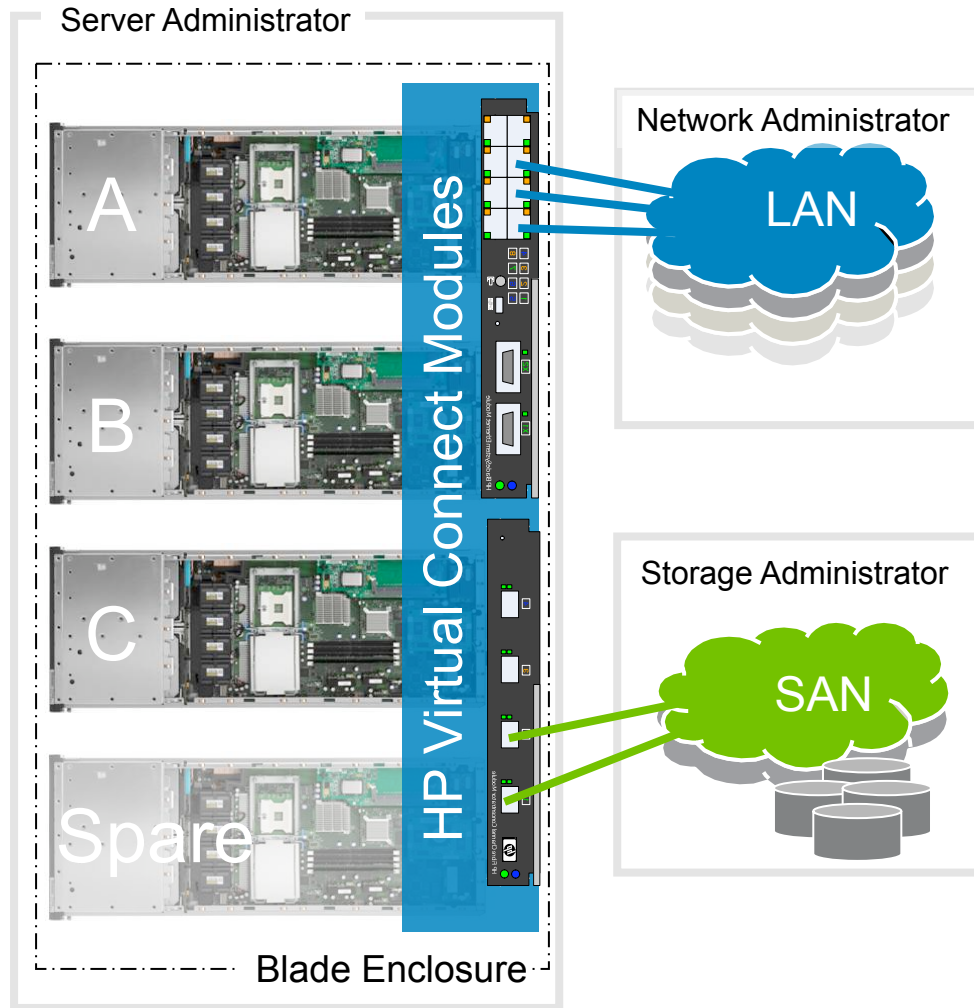

- Reduces cables without adding switches to manage
- No new FC domains
- Maintains end-to-end connections of your favorite brands (Cisco, Nortel, Brocade, McData, etc.)
- Cleanly separates Server from LAN & SAN
- Relieves LAN & SAN admins from server maintenance
- Servers are Change-Ready add, move, replace, upgrade without affecting LAN or SAN
  - MAC & WWN are locally administered so LAN & SAN connections stay constant
- Change servers when your business needs it, not when you can fit it into everyone's calendar

# Managing Virtual Connect infrastructures

## Single and multiple enclosure solutions



Virtual Connect Manager

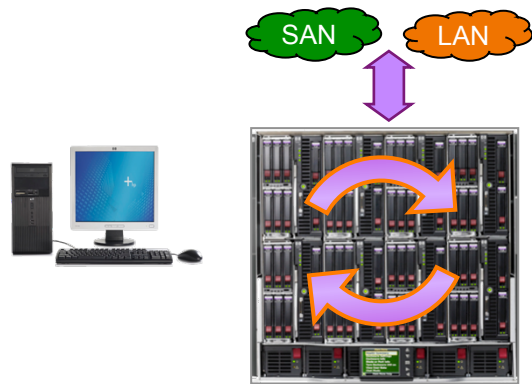

- Web-based console in Virtual Connect Ethernet module firmware
- Configure and manage a single enclosure (VC domain) with up to 16 servers
- Server connections with LAN and SAN assigned per enclosure
- Move servers within an enclosure

Virtual Connect Enterprise Manager

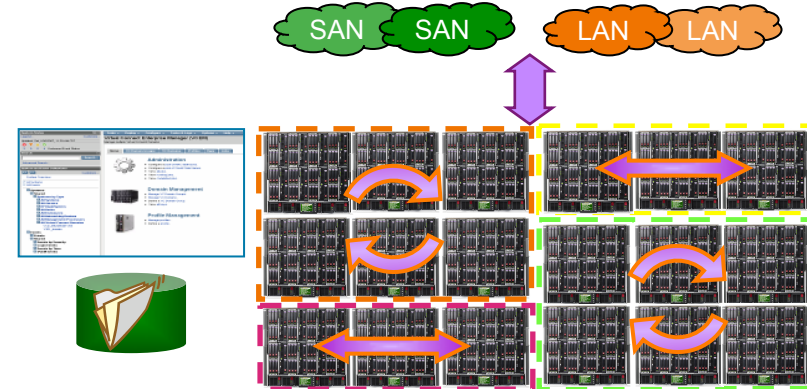

- Application manages 100 enclosures with up to 1600 servers from a single console
- Central database controls server connections to over 65,000 LAN/SAN addresses
- Manage groups of enclosures (VC domains)
- Quickly add, modify, move server resources between enclosures and across the datacenter

# Scalable for small and large infrastructures

## Virtual Connect Manager

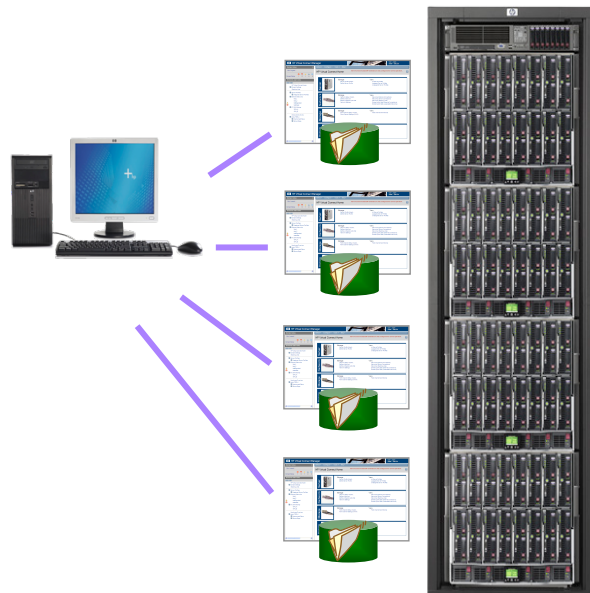

- Ideal for single rack datacenters (3-4 blade enclosures)
- Each enclosure configured and managed independently
- Multiple consoles and address pools

## Virtual Connect Enterprise Manager

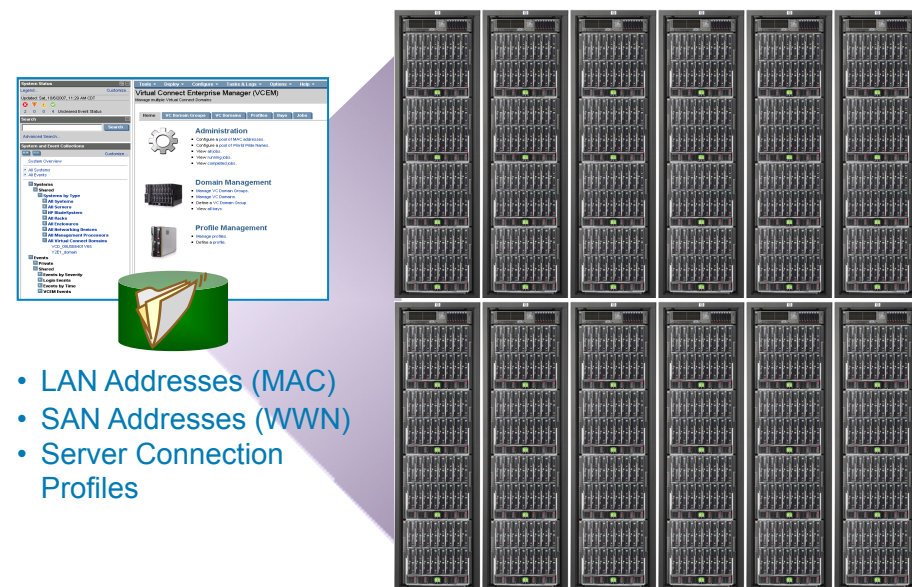

- LAN Addresses (MAC)
- SAN Addresses (WWN)
- Server Connection Profiles

- For multiple racks of enclosures
- Configure and manage groups of enclosures centrally
- Single console and address pool
- Import existing Virtual Connect domains



# HP Virtual Connect Technology overview



# Virtual Connect environment: 3 Key Components to a VC Infrastructure

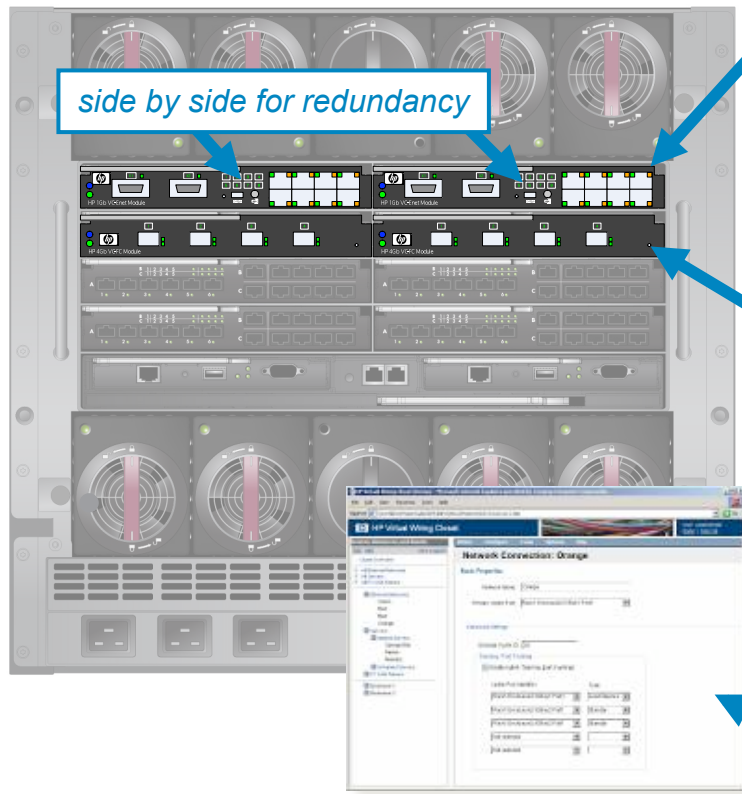

## Virtual Connect Ethernet Modules

- Connect selected server Ethernet ports to specific data center networks.
- Supports aggregation/tagging of uplinks to data center.
- 'LAN-safe' for connection to any data center switch environment (Cisco, Nortel, HP ProCurve, etc.)



## Virtual Connect Fibre Channel Modules

- Selectively aggregate multiple server FC HBA ports (Qlogic/Emulex) on a FC uplink using NPIV.
- Connect enclosure to Brocade, Cisco, McData, or Qlogic data center FC switches.
- Doesn't appear as a switch to the FC fabric.



## Virtual Connect Manager *(embedded!)*

- Manage server connections to the data center without impacting the LAN or SAN
- Move/upgrade/change servers without impacting the LAN or SAN

# HP 1/10Gb Virtual Connect Ethernet Module

MidPlane 16x 1Gb Ethernet – *Connects to one NIC in each HH blade server bay*  
1x 10Gb – *Cross-link between adjacent VC-Enet modules*  
Mgmt Interfaces to Onboard Administrator

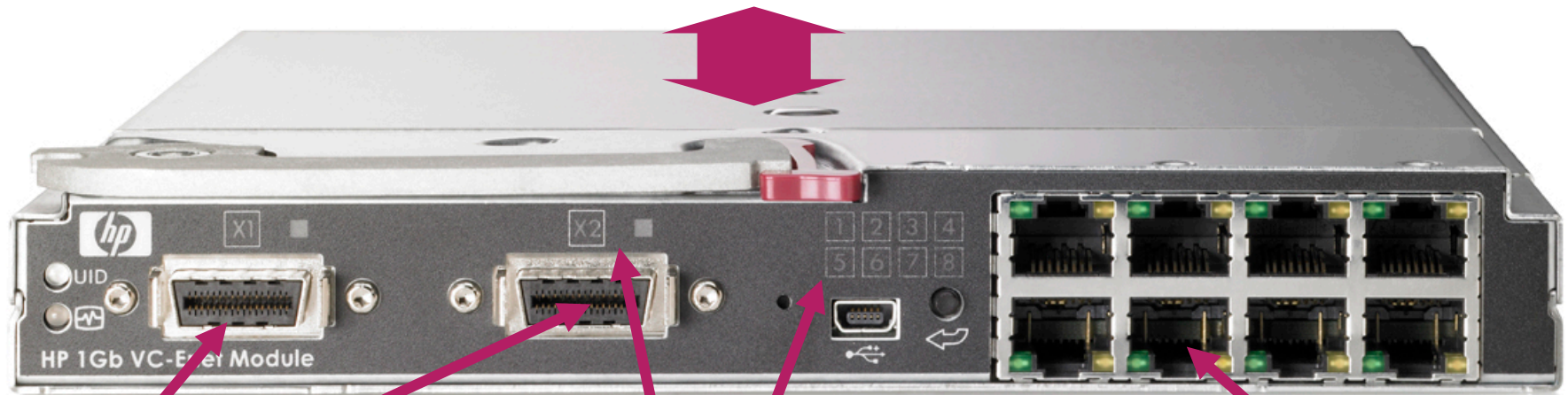

**2x 10Gb Ethernet (CX4)**  
*Usable as data center links or as stacking links.*

**Port Number & Status Indicators**  
*Indicates whether a data center link (green), stacking link (amber), or highlighted port (blue).*

**8x 1Gb Ethernet (RJ45)**  
*Usable as data center links or as stacking links.*

# HP 1/10Gb-F Virtual Connect Ethernet Module

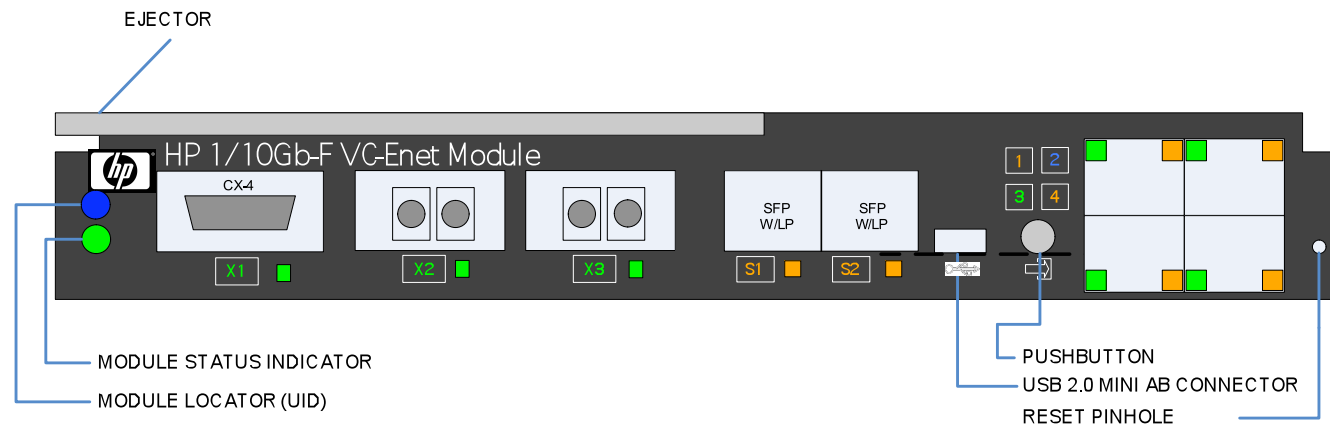

- Gigabit Ports (22 total)
  - 2 SFP (1000Base-X)
  - 4 RJ45 10/100/1000Base-T
  - 16 SERDES 1000Base-X Server Downlinks
- 10Gigabit Ports (4 total)
  - 1 CX4 Front
  - 1 CX4 ISL
  - 2 XFP

# HP Virtual Connect FC Module

MidPlane 16x 4Gb FC – Connects to one HBA port in each HH blade server bay  
Mgmt Interfaces to Onboard Administrator

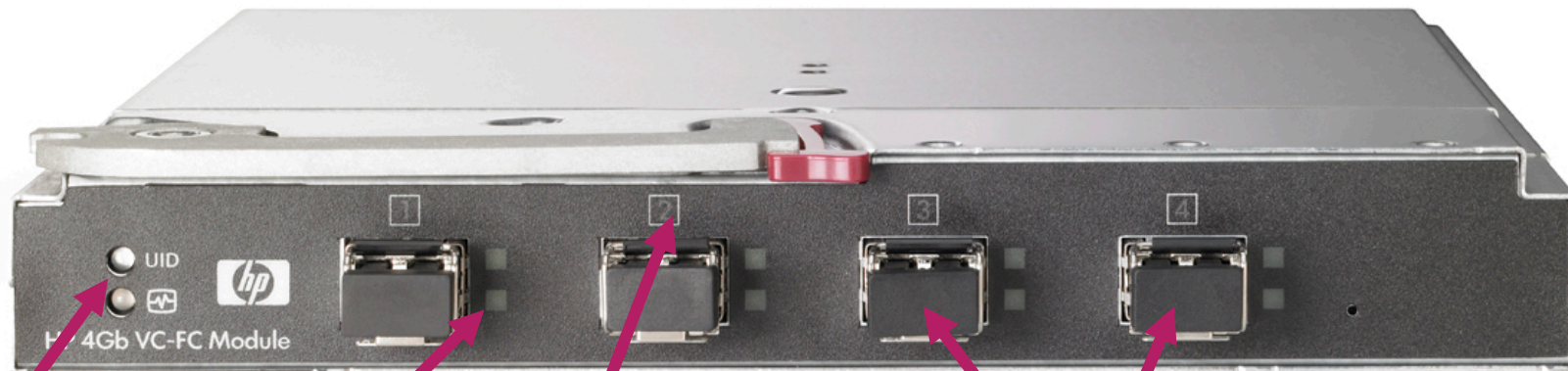

Module LEDs  
*Health and UID*

Port LEDs  
*Link and Activity*

Port Number & Status Indicators  
*Indicates whether a port is configured (green)  
or highlighted (blue).*

4x 1/2/4 Gb FC (SFP)  
*Connects to data center Fibre  
Channel switches.*

Faceplate

Note: VC-FC requires VC-Ethernet  
also installed in same VC domain



# VC-Enet Modules may be 'Stacked'

Any server NIC can access any data center uplink

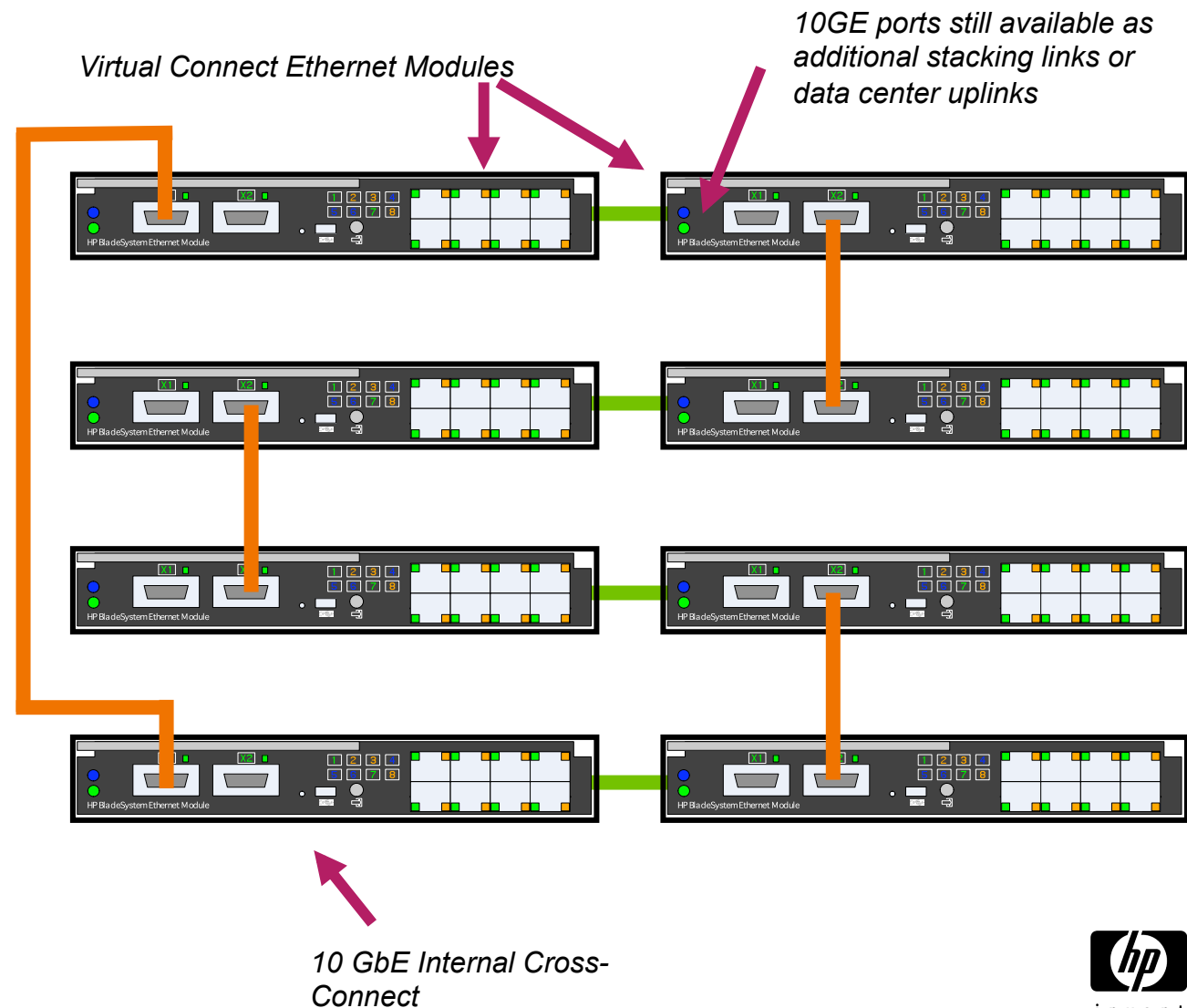

- Every server in domain has access to any data center LAN connection
- Every server has fault-tolerant access to every uplink port
- With this stacking method, every Virtual Connect module still has 8 -1GbE and 1 -10GbE uplink ports available



# HP Virtual Connect Configuration

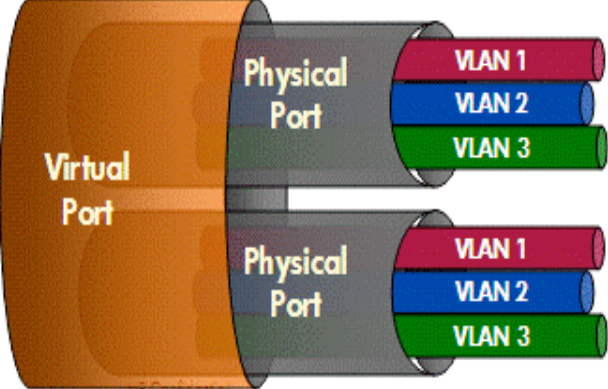

# Terminology

Cisco Terms/ Protocol	Industry Terms/ Protocol	HP VC Terms/ Protocol	Diagram
Trunking *(ISL)	Vlan Trunking (802.1Q)	Shared Uplink (802.1Q)	
Channeling *(PAGP)	Port Trunking (LACP)	Auto (LACP)	
Trunking + Channeling *(ISL + PAGP)  * Cisco Proprietary protocols. Cisco switches are also compatible with industry standard protocols.	Vlan Trunk + Port Trunk (802.1Q + LACP)	Shared Uplink+ Auto (802.1Q + LACP)	



Blade Slot #

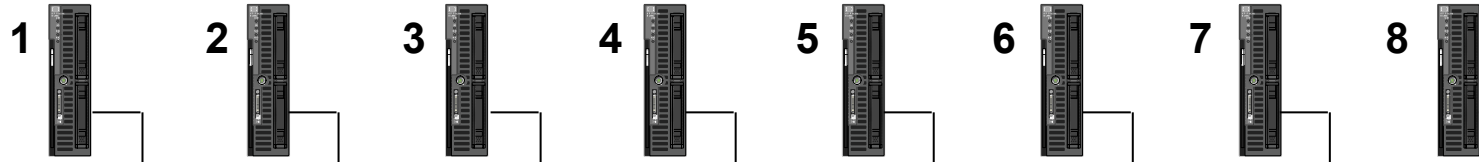

LOM 1

Create a VC Domain

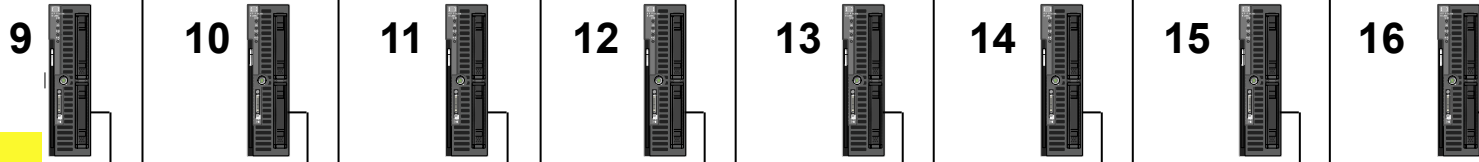

VC-Enet Bay 1

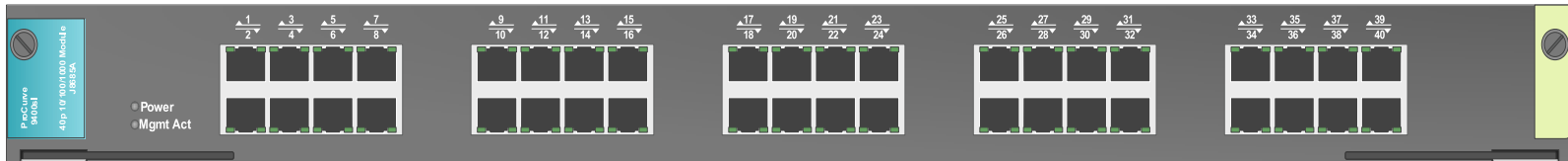
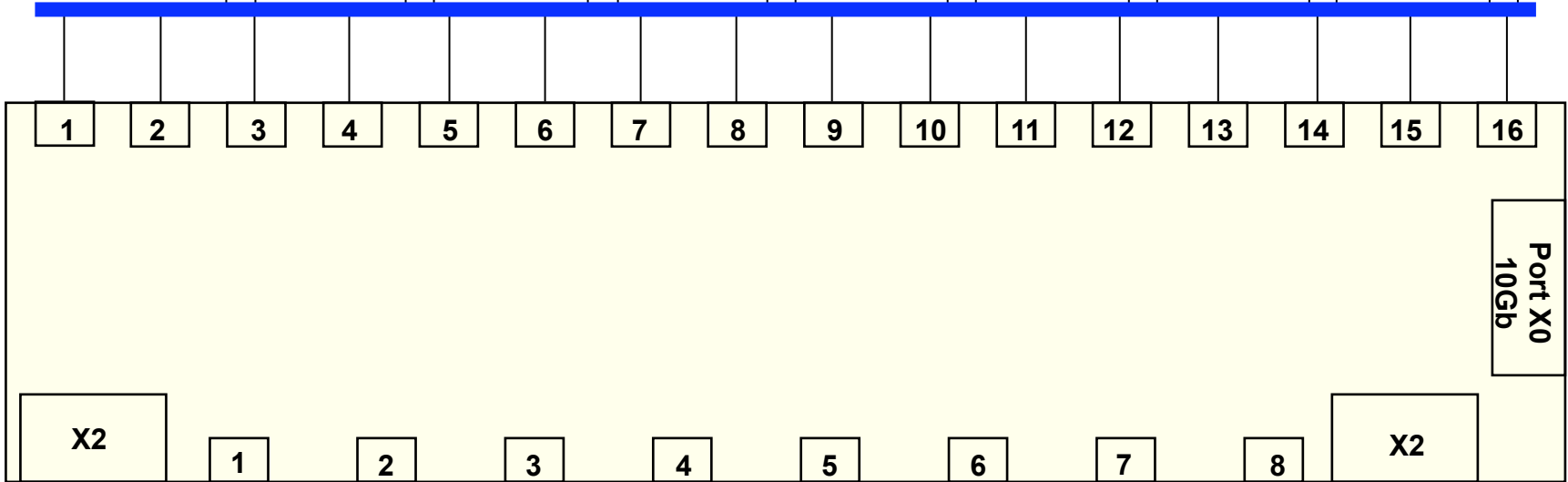

Blade Slot #

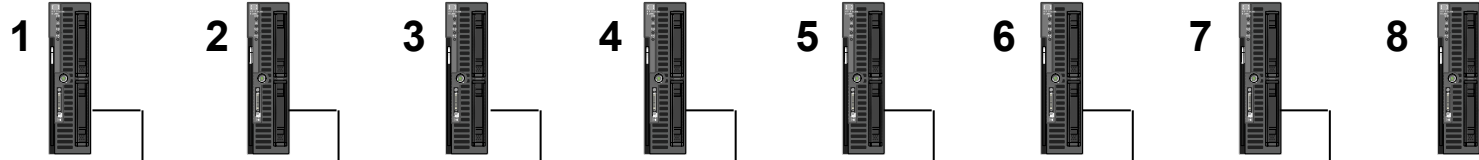

LOM 1

Create VC Networks

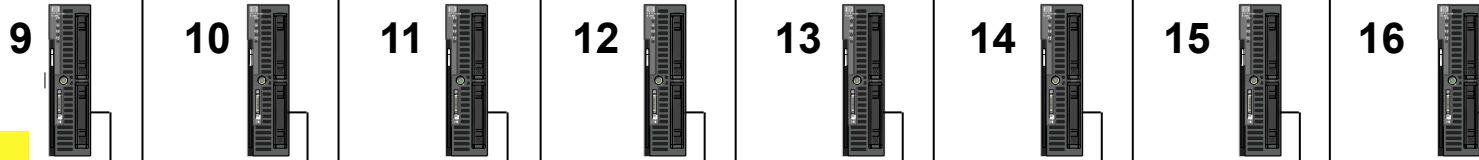

VC-Enet Bay 1

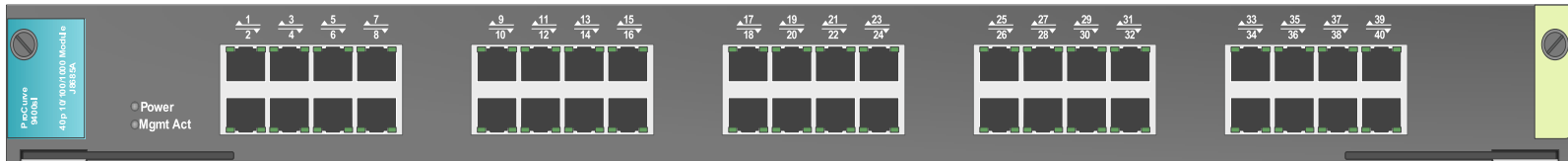
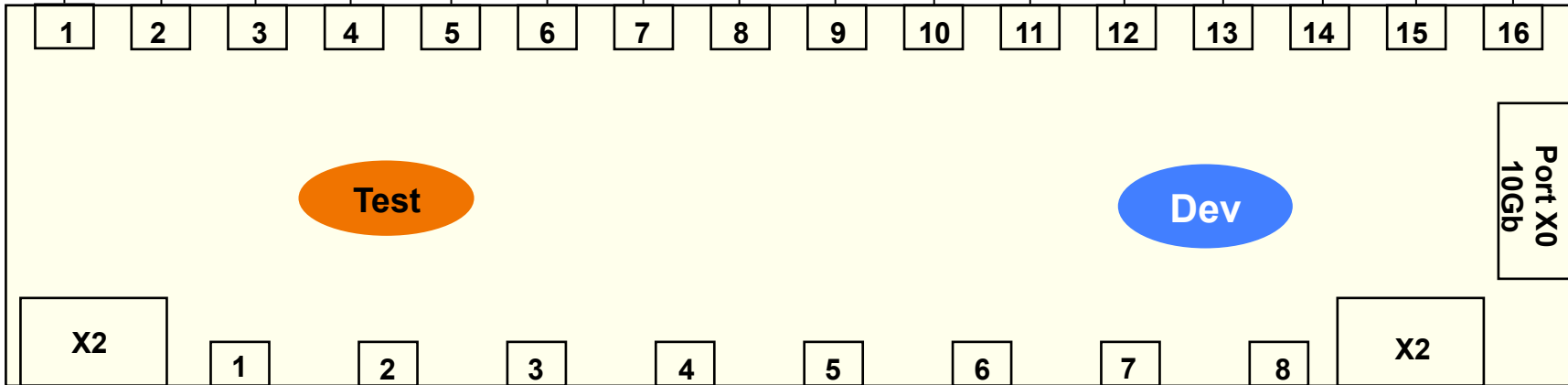

Blade Slot #

LOM 1

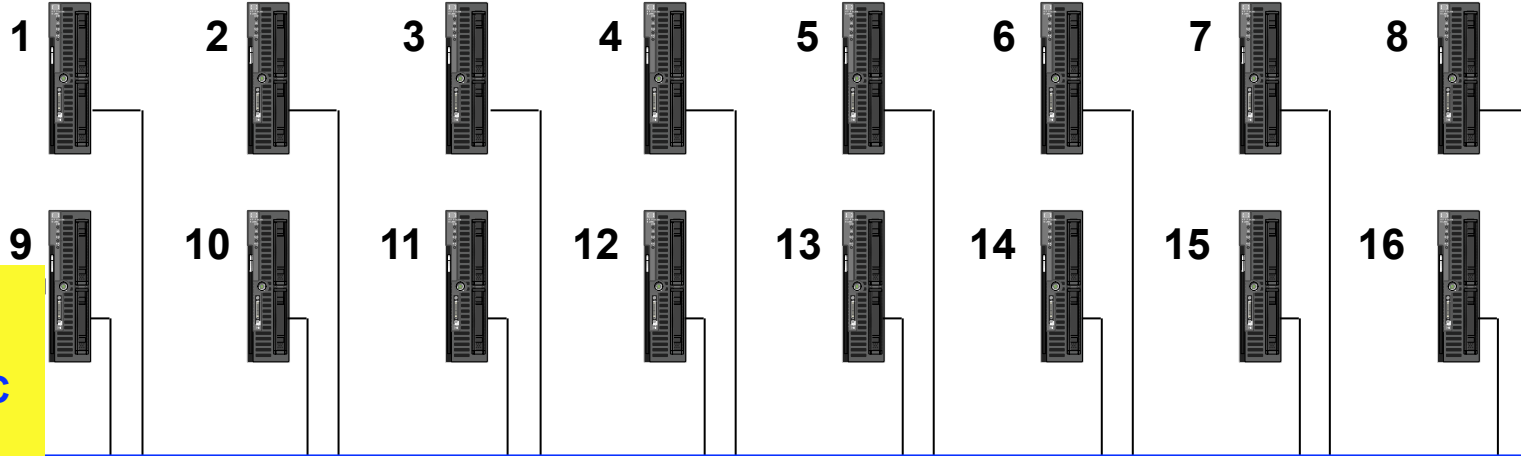

VC-Enet Bay 1

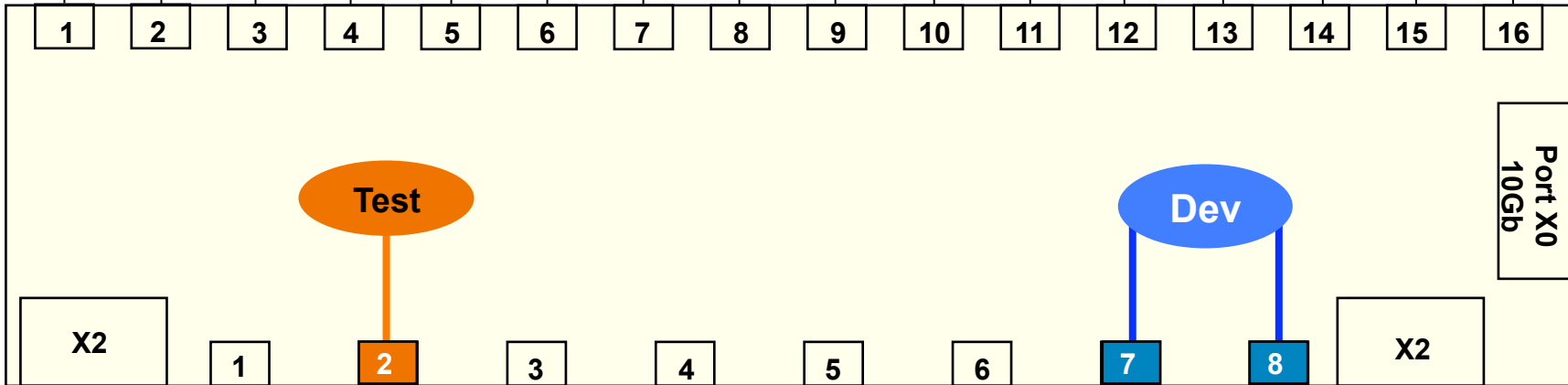

LACP 802.3ad

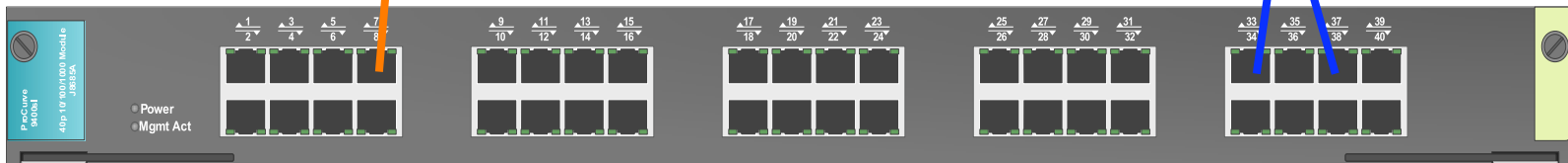

Blade Slot #

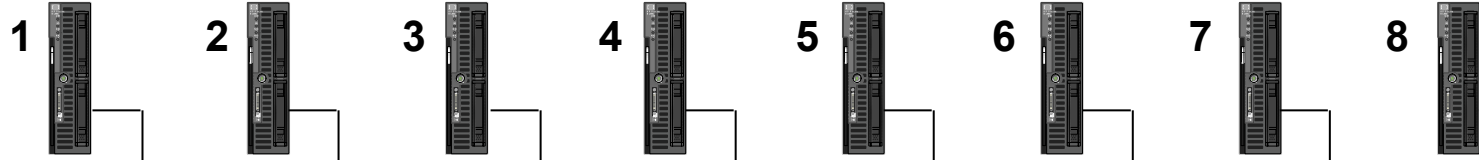

LOM 1

Define a Shared Uplink Set (SUS)

VC-Enet Bay 1

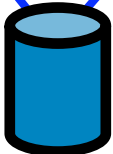
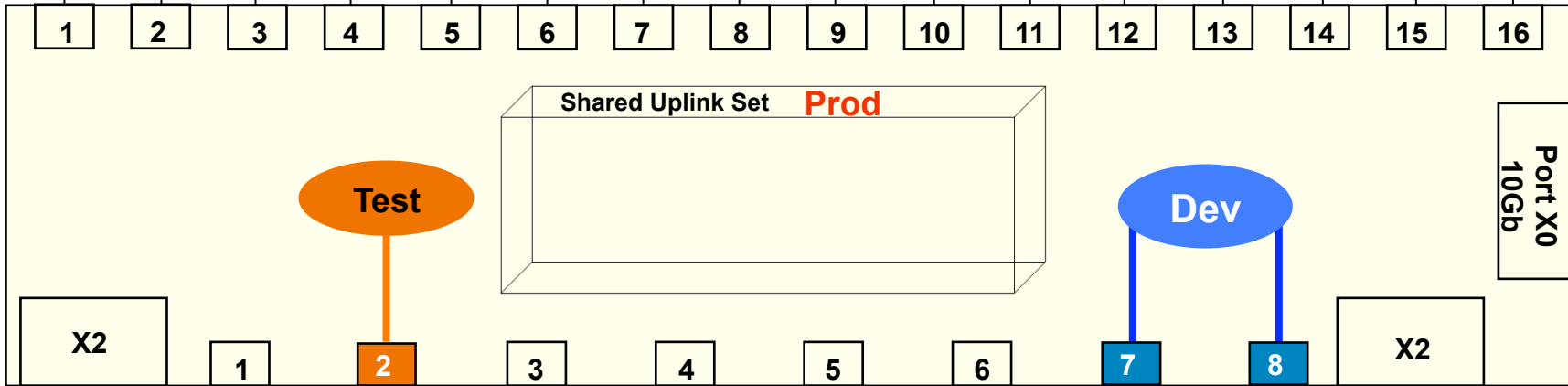

LACP 802.3ad

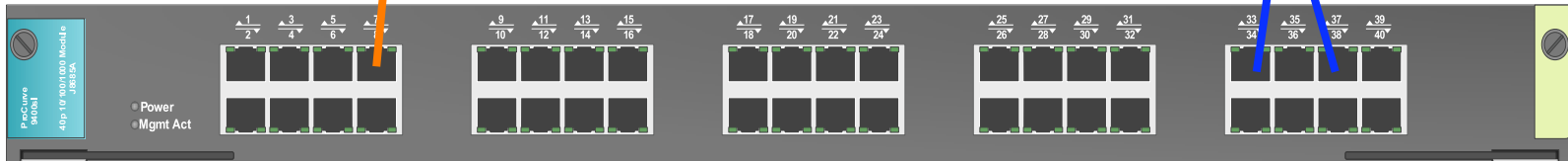

Blade Slot #

LOM 1

Associate  
SUS Prod  
to Uplink  
Ports

VC-Enet Bay 1

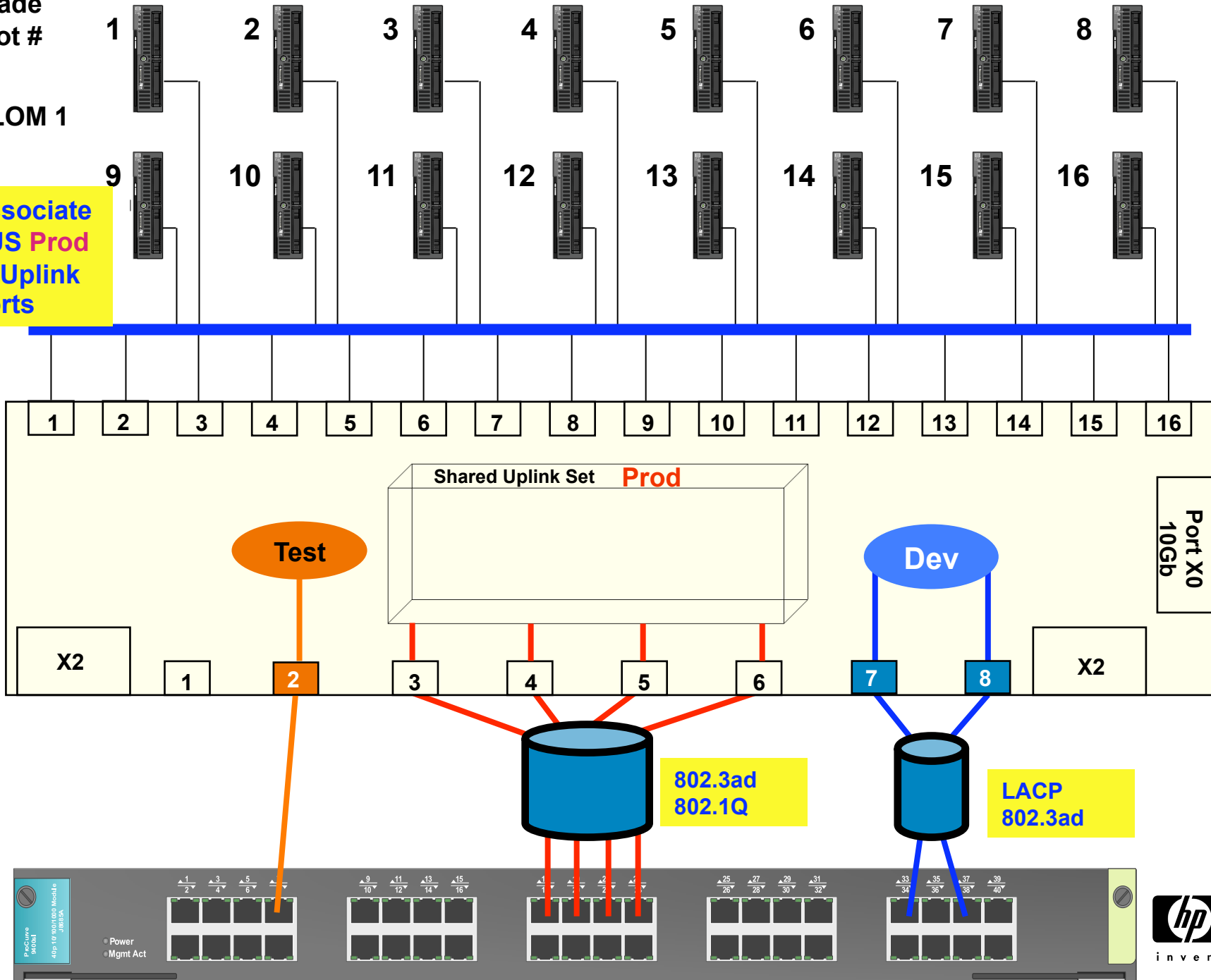

Blade Slot #

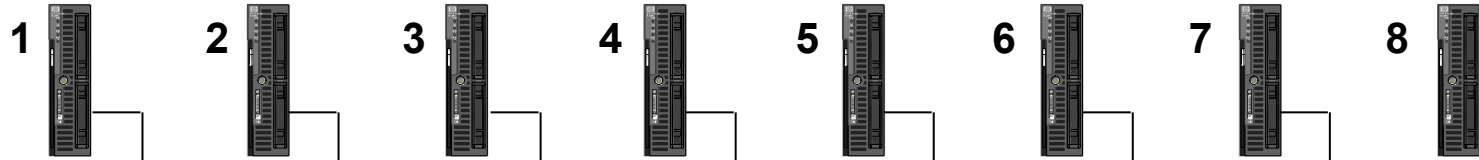

LOM 1

Define & Associate VLAN Nets with SUS Prod

VC-Enet Bay 1

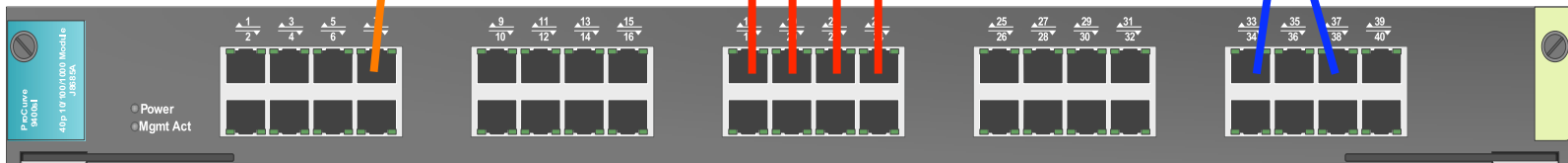
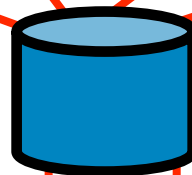
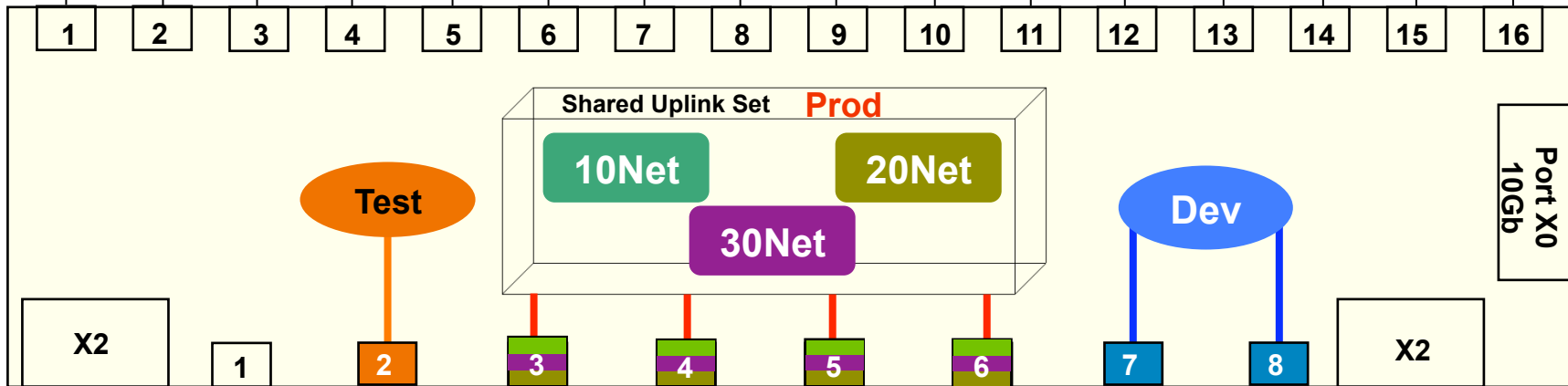

Blade Slot #

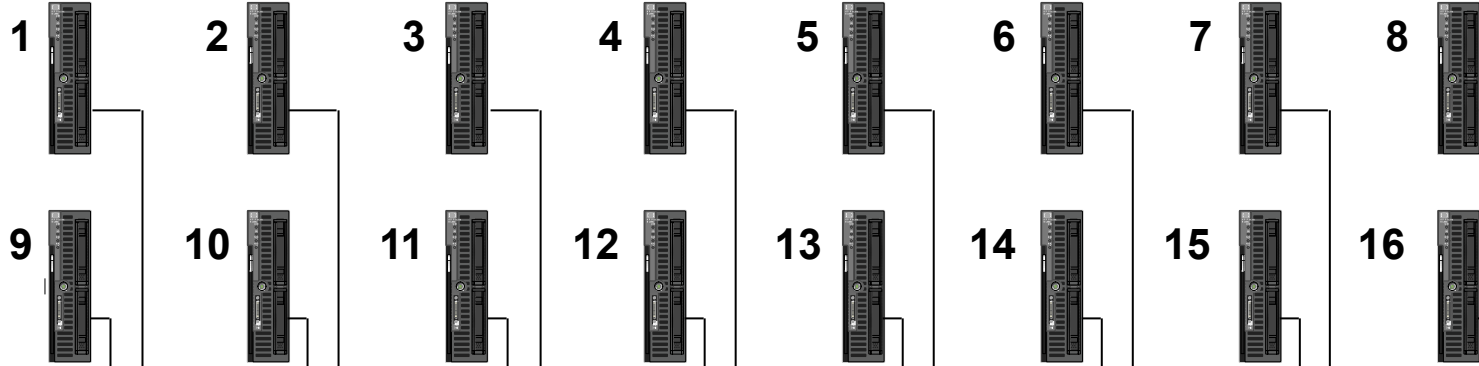

LOM 1

Create Server Profiles

VC-Enet Bay 1

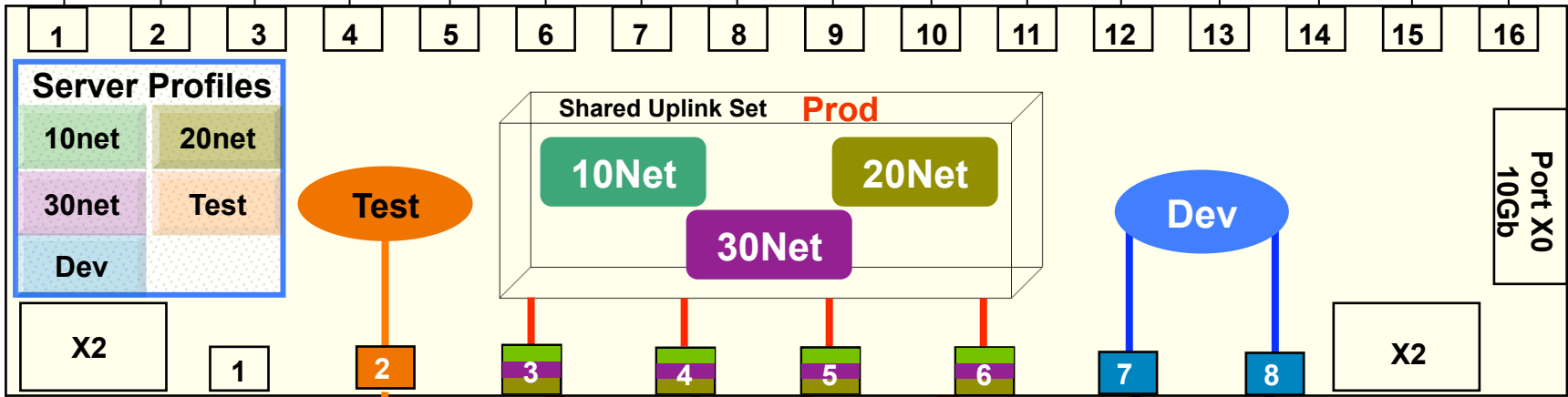

- Profiles Define:
- Network Connections
  - MAC Addresses
  - FC World Wide Names
  - FC SAN Connections
  - FC Boot Parameters

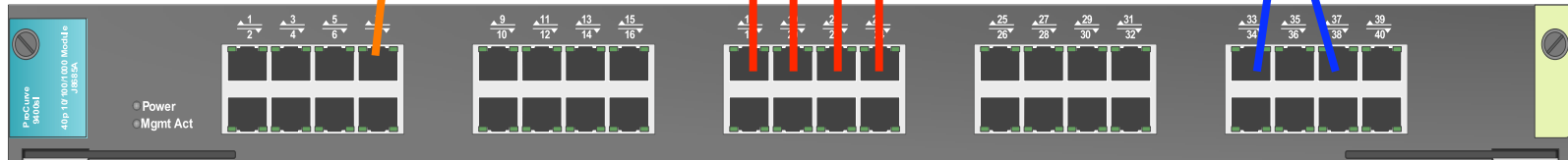

Blade Slot #

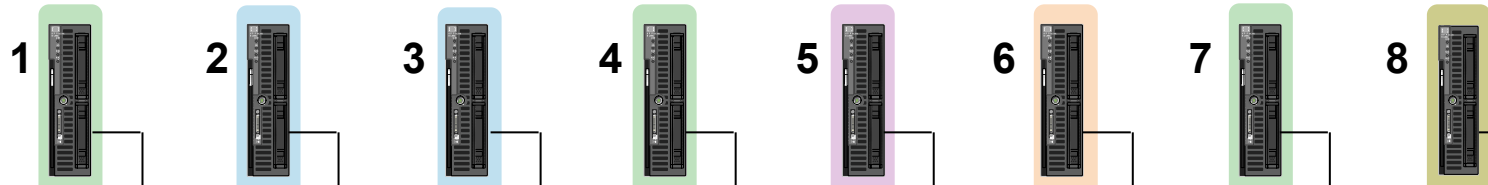

LOM 1

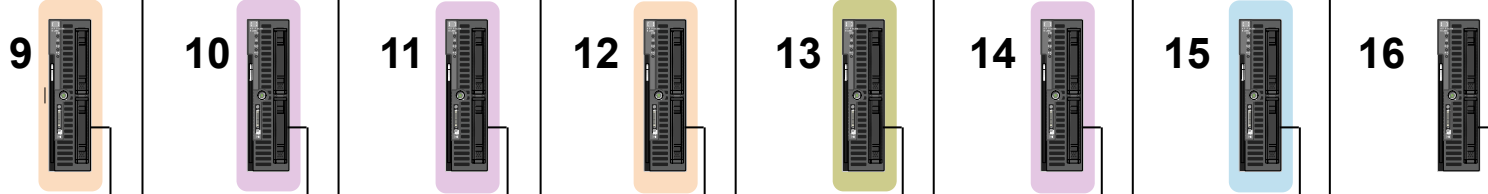

Assign Server Profiles

VC-Enet Bay 1

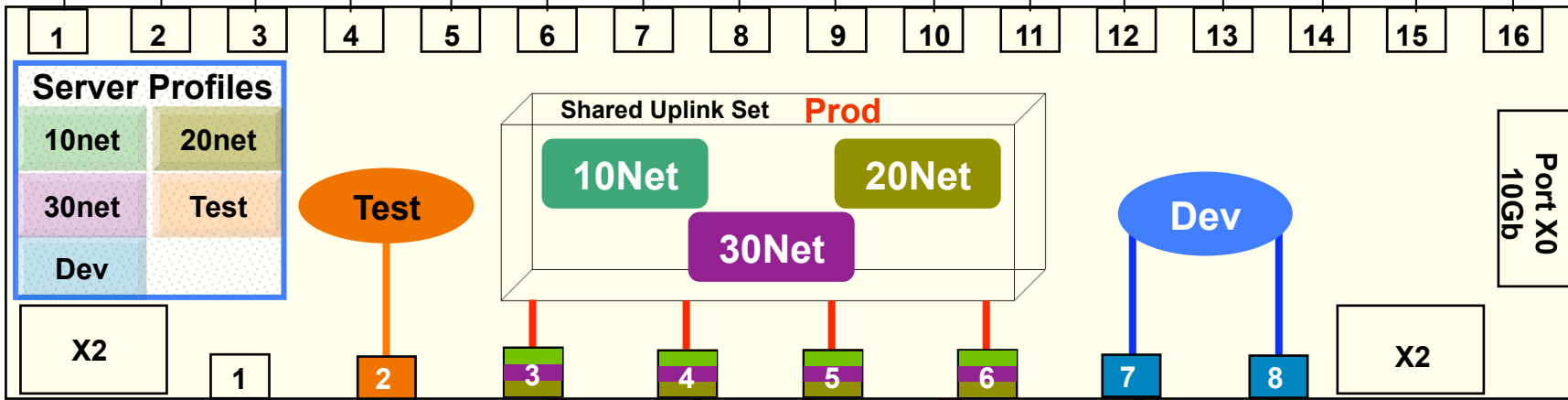

Profiles Define:

- Network Connections
- MAC Addresses
- FC World Wide Names
- FC SAN Connections
- FC Boot Parameters

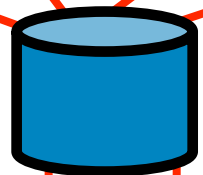

802.3ad  
802.1Q



802.3ad

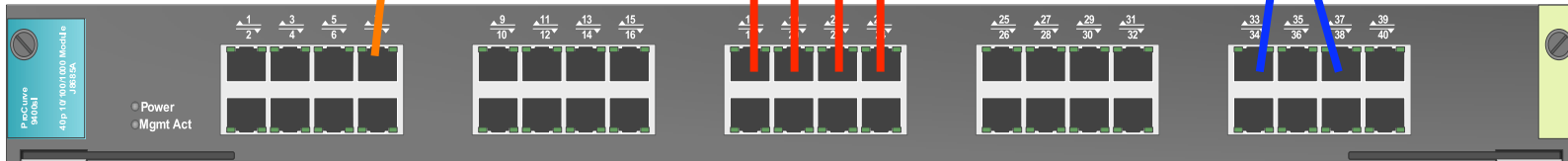



Blade Slot #

LOM 1

Power On Servers

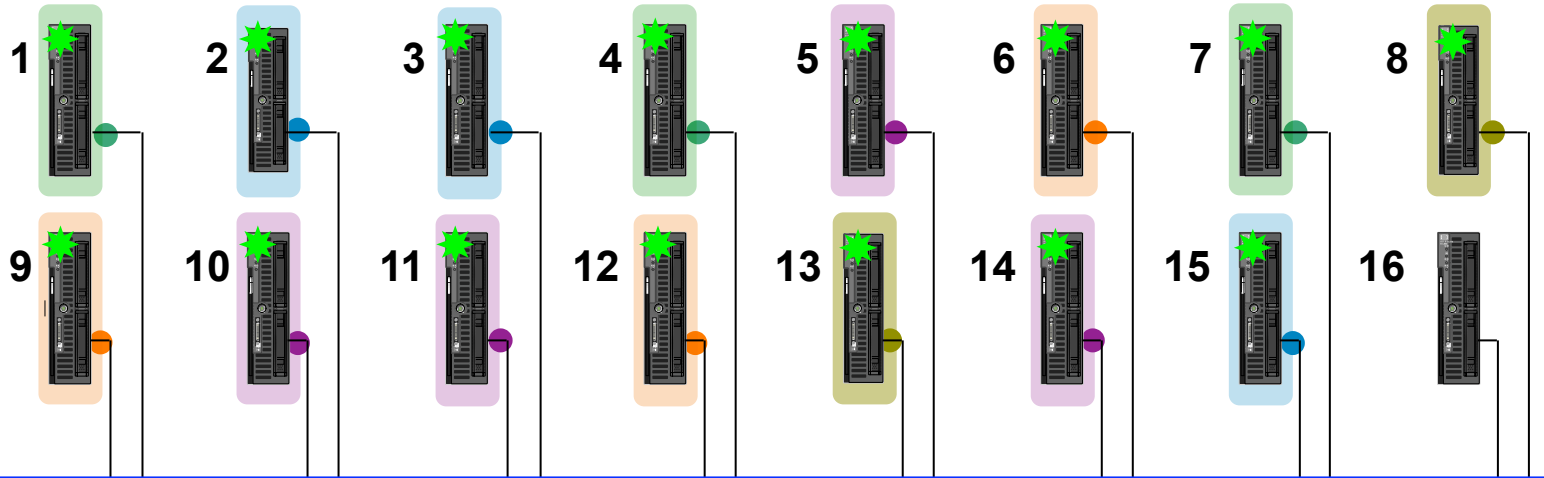

VC-Enet Bay 1

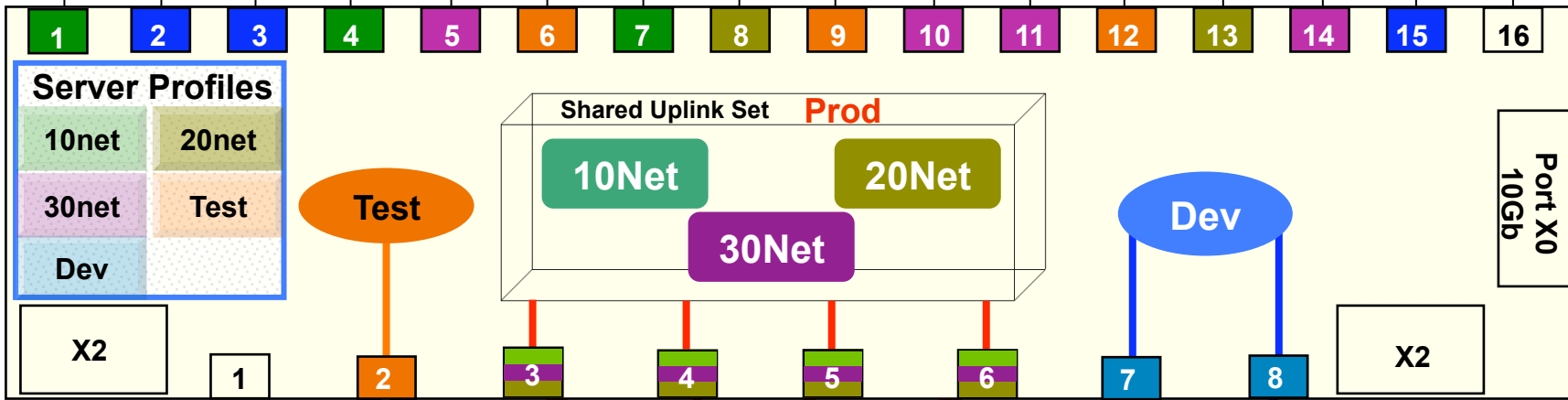

Profiles Define:

- Network Connections
- MAC Addresses
- FC World Wide Names
- FC SAN Connections
- FC Boot Parameters

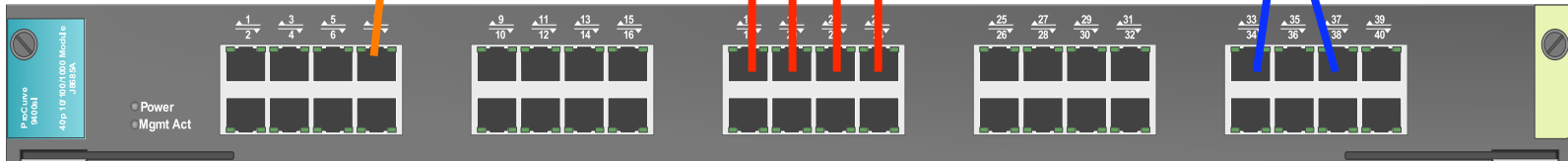
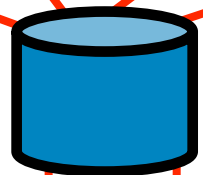

Blade Slot #

LOM 1

Server Failure

Move Profile

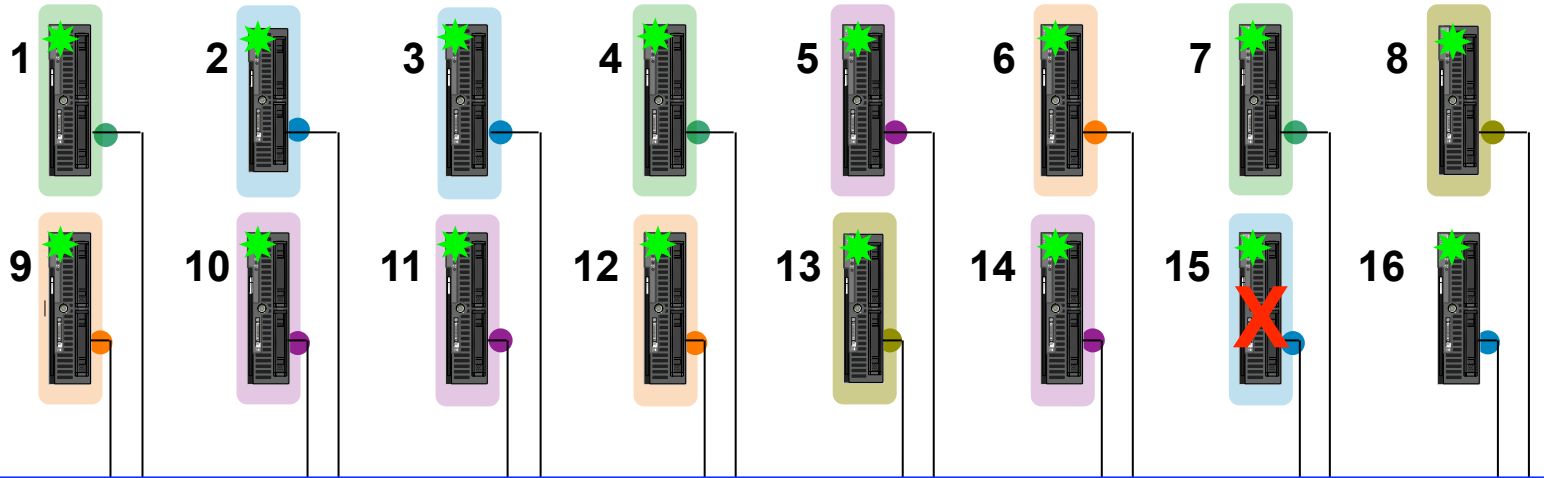

VC-Enet Bay 1

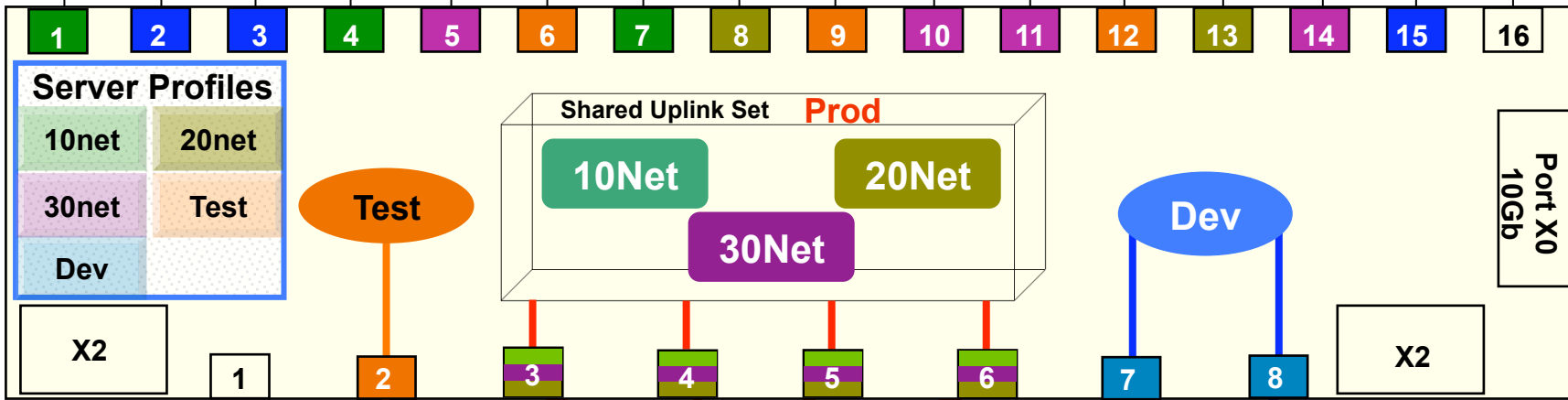

Profiles Define:

- Network Connections
- MAC Addresses
- FC World Wide Names
- FC SAN Connections
- FC Boot Parameters

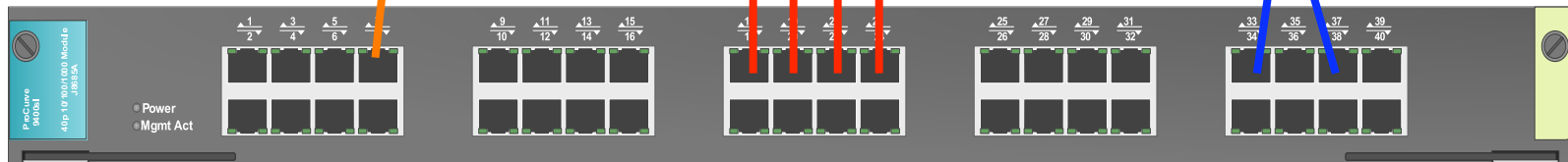
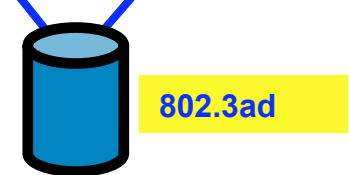
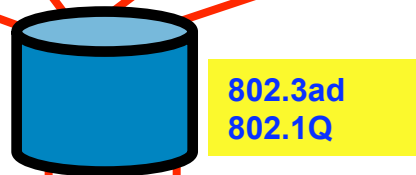

Blade Slot #

BL480C LOMs 1 & 3

Host Based VLANs 802.1Q

VMware ESX 3.x

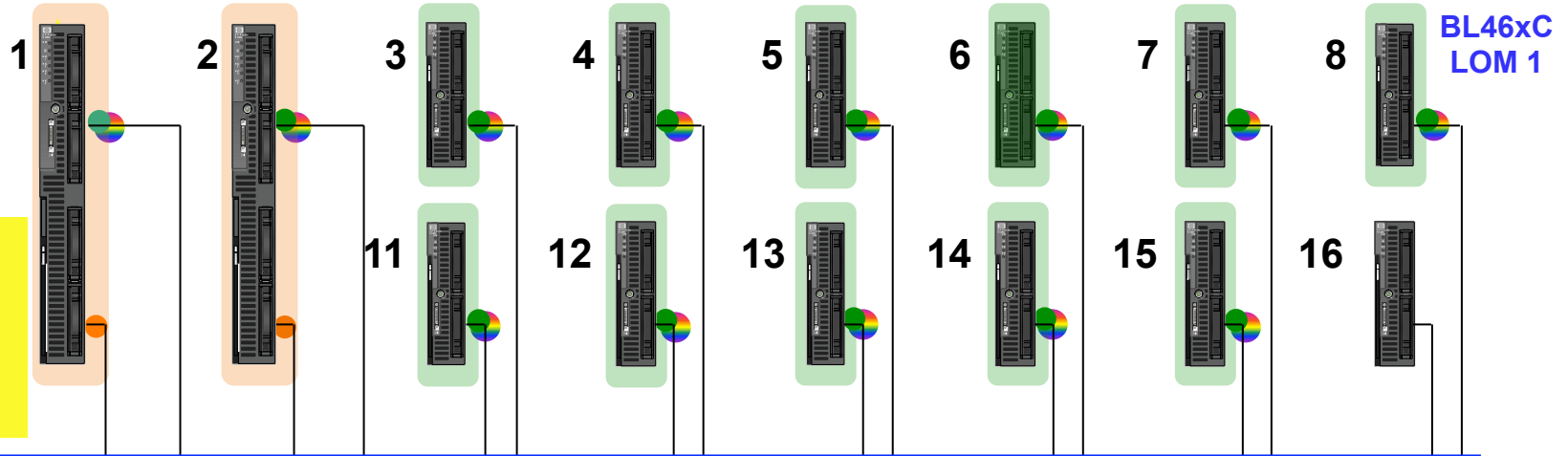

VC-Enet Bay 1

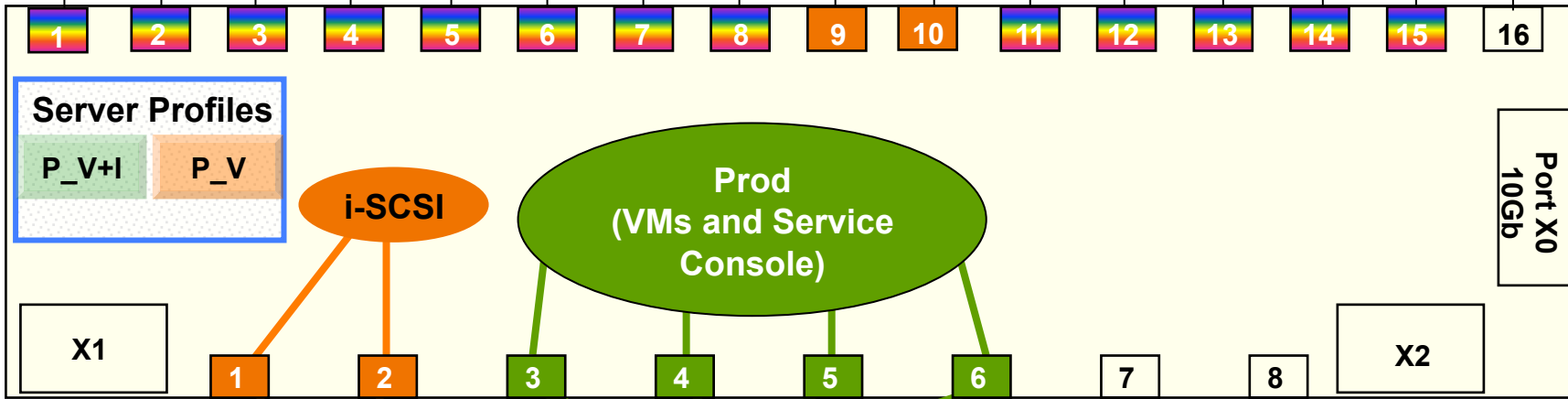

Profiles Define:

- Network Connections
- MAC Addresses
- FC World Wide Names
- FC SAN Connections
- FC Boot Parameters

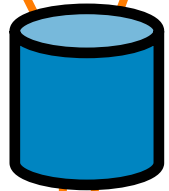

802.3ad

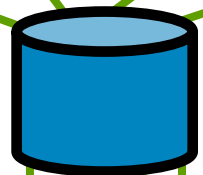

802.3ad



Blade Slot #

BL480C LOMs 1 & 3

Host Based VLANs 802.1Q  
VMware ESX 3.x

Power on

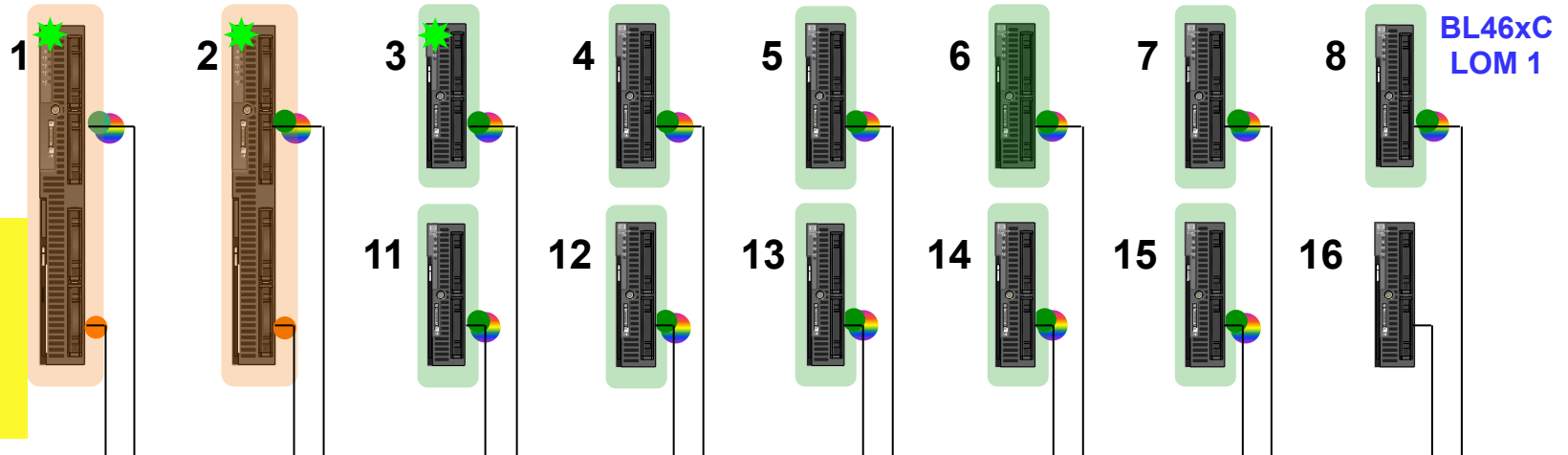

VC-Enet Bay 1

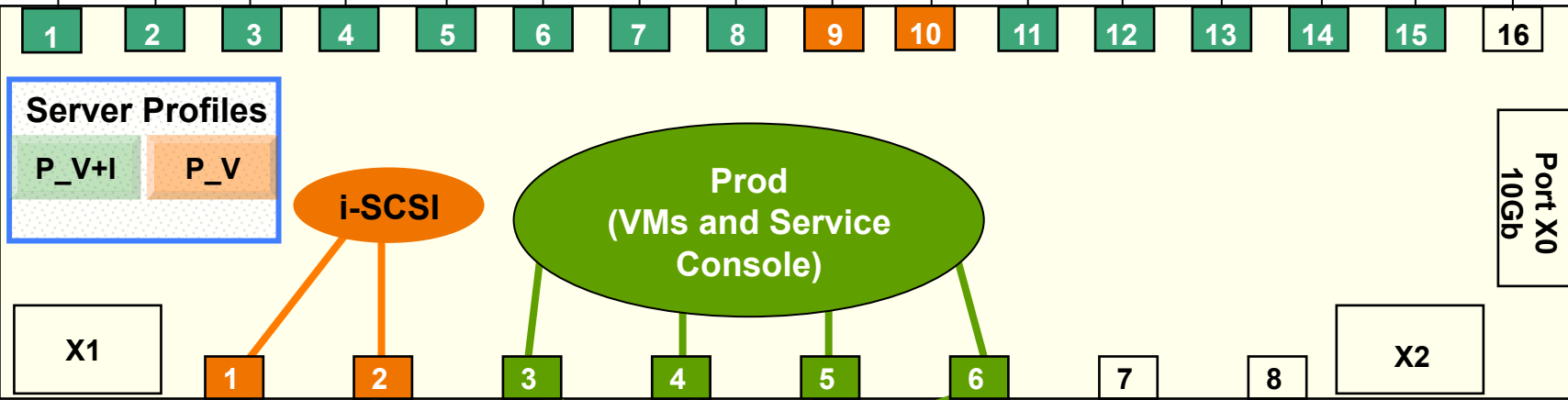

Profiles Define:

- Network Connections
- MAC Addresses
- FC World Wide Names
- FC SAN Connections
- FC Boot Parameters



Blade Slot #

LOM 1

Multiple VLANs sharing a single port

VC-Enet Bay 1

- Profiles Define:
- Network Connections
  - MAC Addresses
  - FC World Wide Names
  - FC SAN Connections
  - FC Boot Parameters

Multiple VLANs per port (IEEE 802.1Q) on the uplink switch.

VC Shared Uplink Set carries multiple VLANs to the same uplink port.

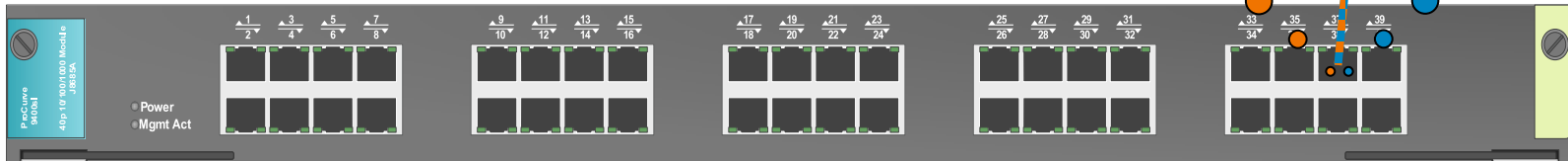
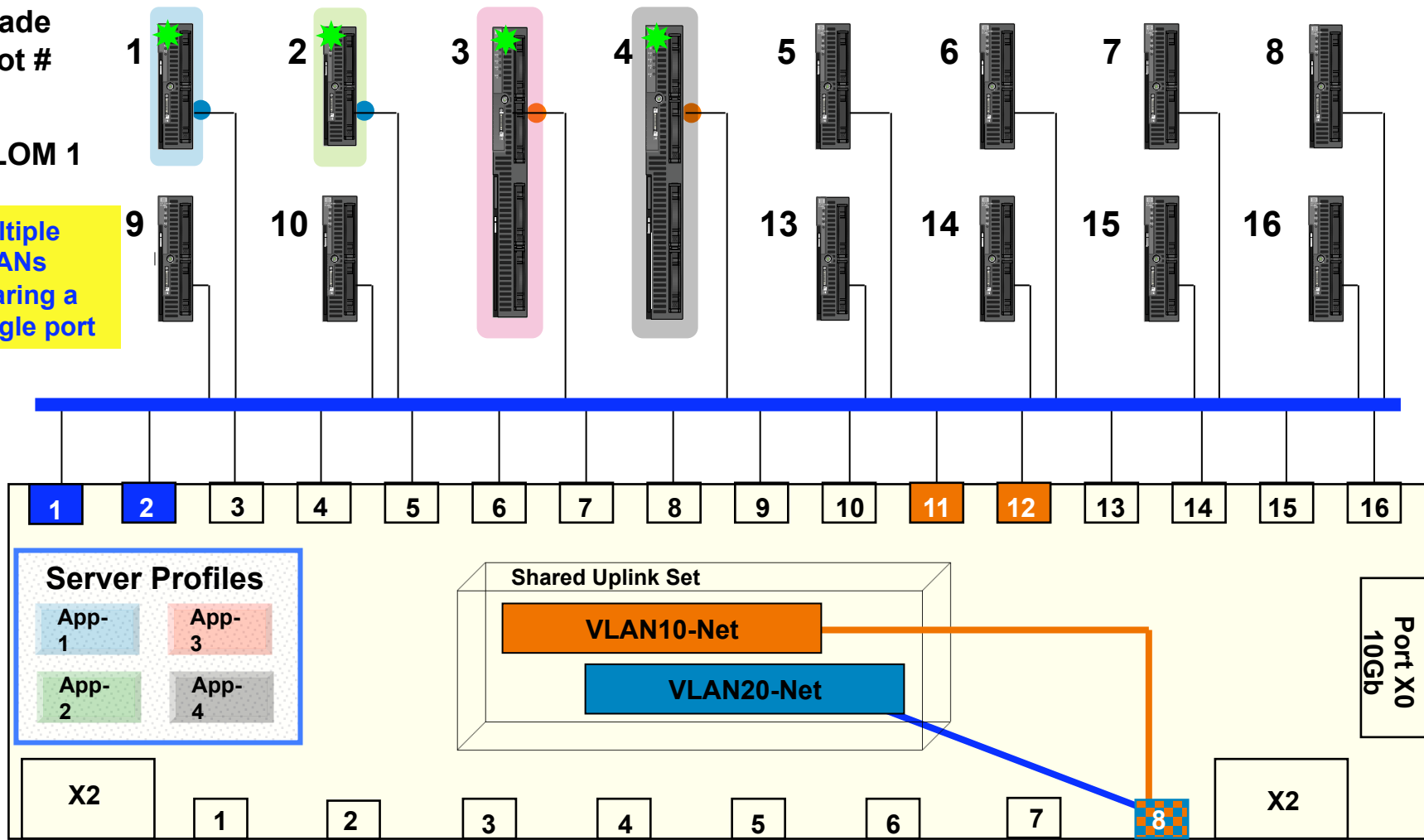

# A Few Questions to Anticipate

Q: Is the Virtual Connect Ethernet module a switch?

A: No. It is a bridging device. More to the point, it is based upon IEEE802.1 Industry Standard Bridging Technologies.

Q: How does the Virtual Connect Ethernet module avoid network loops?

A: It does so by doing two things. First the VC-E makes sure that there is only one active uplink (or uplink LAG) for any single network at any one time so traffic can't loop through from uplink to uplink. Second, the VC-E automatically discovers all the internal stacking links and uses an internal loop prevention algorithm to ensure there are no loops caused by the stacking links. None of the internal loop prevention traffic ever shows up on uplinks or would go to the external switch.

Q: Is the Virtual Connect Ethernet module running Spanning Tree?

A: VC uses an internal loop prevention algorithm that only shows up on stacking links. VC-E does not run spanning tree protocol on network uplinks. This internal loop prevention prevent loops by creating an internal tree within the confines of the VC environment.

Q: Will the "HP loop prevention technology" interact with my existing network's Spanning Tree?

A: No. The VC-E device will be treated as an end point, or dead-end device on the existing network. The loop prevention technology is only utilized on stacking links internal to a VC Domain and never shows up on uplinks into the data center.



# Virtual Connect Flex-10 10Gb Ethernet Module



Technology for better business outcomes

# Virtual Connect Flex-10

First single-wide  
10Gb Ethernet  
interconnect  
module

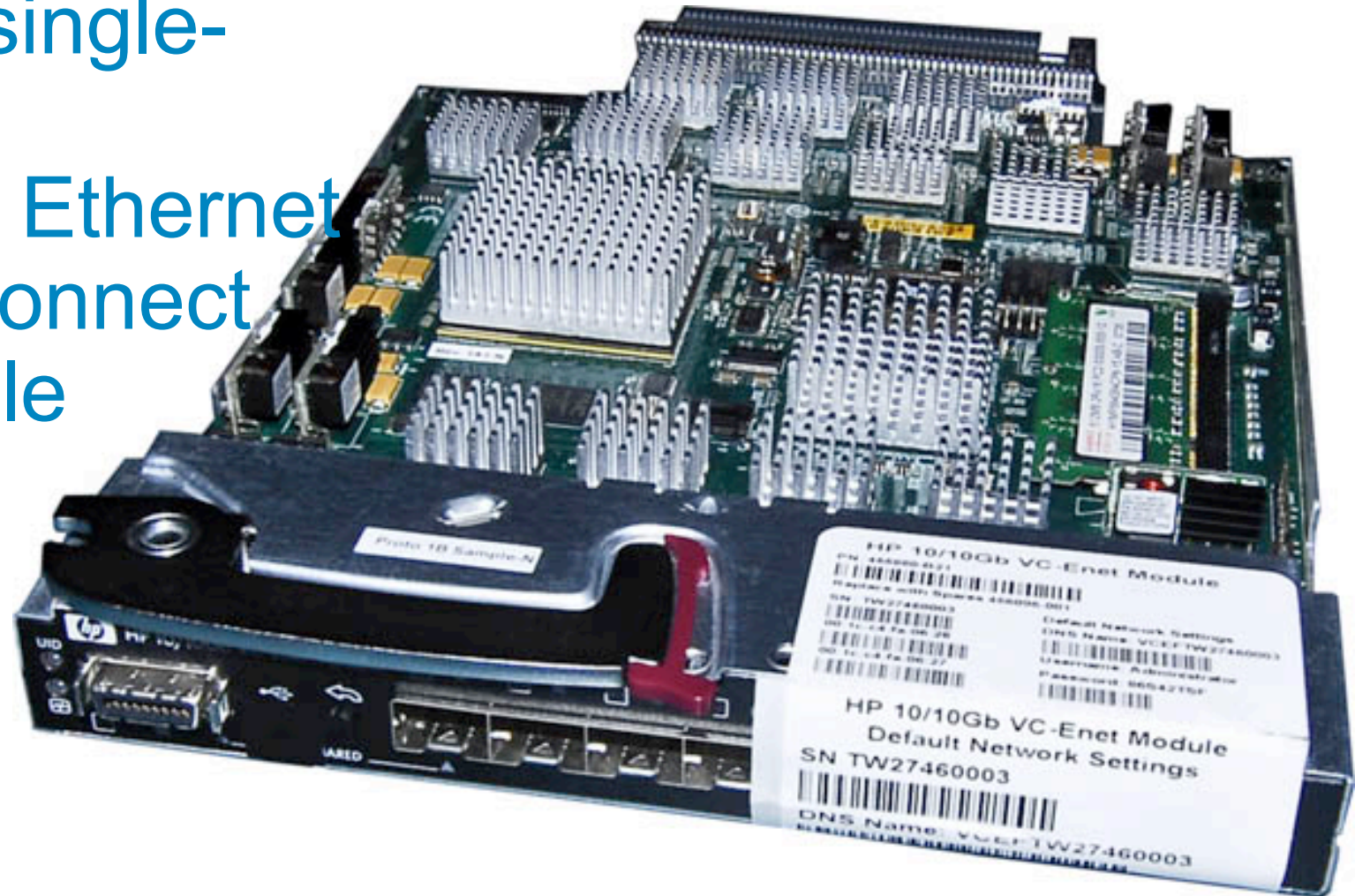



# HP 10/10Gb VC-Enet Module

MidPlane: 16x 10GBASE-KR Ethernet – Connects to one (1Gb or 10Gb) NIC in each HH blade bay

2x 10Gb Ethernet – Cross-link between adjacent VC-Enet modules

Mgmt Interfaces to Onboard Administrator (Enet & I2C)

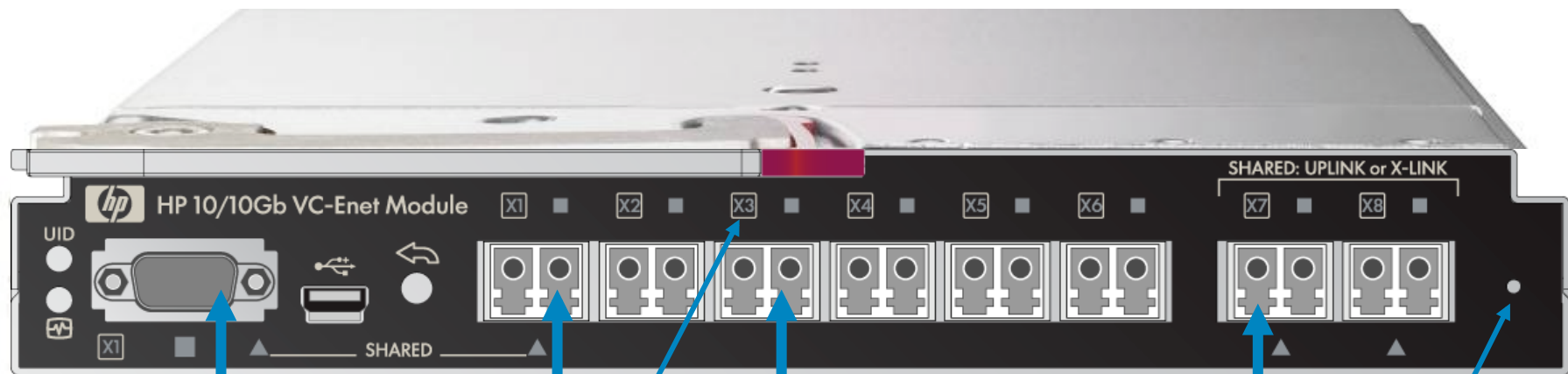

1x 10GBASE-CX4 Ethernet or  
1x SFP+ module (X1)

5x SFP+ modules (X2-6)  
(1GbE or 10GbE)

2x Crosslinks (midplane) or  
2x SFP+ module (X7-8)

**Port Number & Status Indicators**  
Indicates whether a data center link (green),  
stacking link (amber), or highlighted port (blue).

Recessed  
module reset  
button

# Traditional blade servers need too many modules & mezz cards!

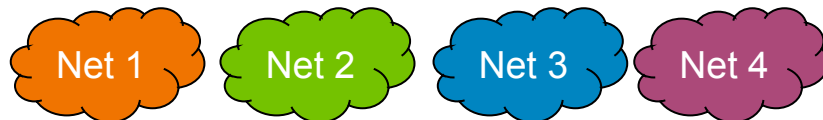
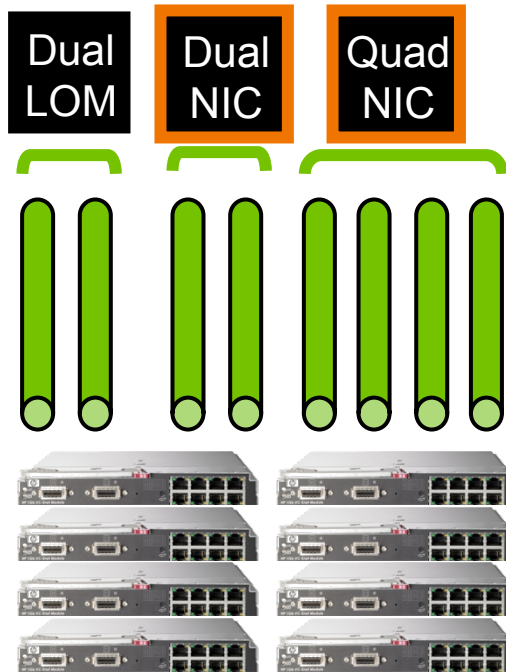

8  
NICs require

2  
Mezz cards

8  
Interconnect Modules

4  
Redundant networks

# VC Flex-10 drops Mezz & Modules by 75%!

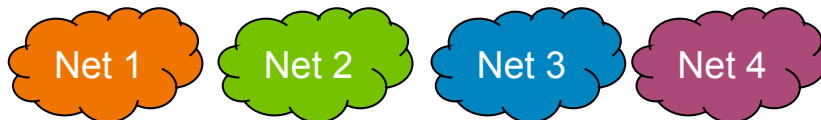
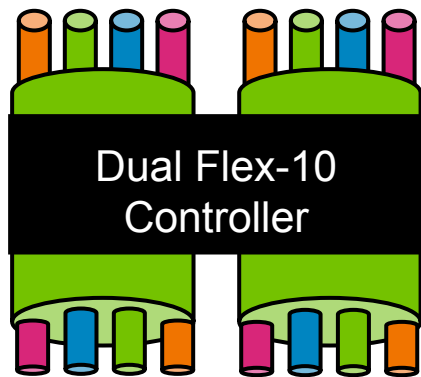

8  
NICs require

~~2~~ → 0  
Mezz cards

~~8~~ → 2  
Interconnect Modules

4  
Redundant networks

First ever to provide precise control over bandwidth per NIC connection

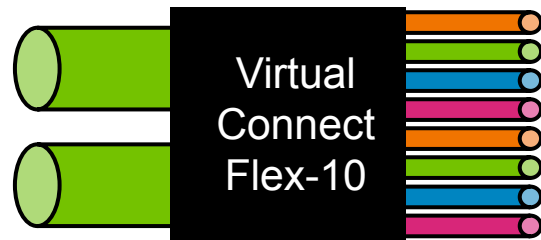

Fine-tune the speed of each network connection

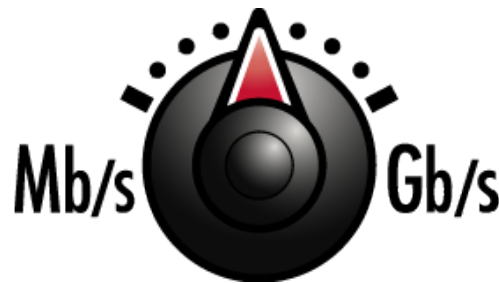

In 100Mb increments from  
**100Mb to 10Gb**

( So you can set and prioritize performance for each VM channel )

# Flex-10 delivers the most flexibility to configure VM channel performance

	Production NIC #1	Vmotion NIC #2	Console NIC #3	Backup NIC #4
Traditional 1Gb technology	1Gb	1Gb	1Gb	1Gb
Virtual Connect Flex-10	2Gb	2.9Gb	100Mb	5Gb



Optimize & prioritize performance  
per channel based on  
your business priorities



# Introducing the next Virtual Connect breakthrough Virtual Connect Flex-10 technology

- **4X more I/O connections per server**
  - Dual-channel 10Gb Flex-10 NIC onboard delivers 8 FlexNICs on the motherboard
  - 24 FlexNIC connections per server via expansion slots
  - 100% hardware-level performance
  - User-adjustable bandwidth from 100Mb to 10Gb for each FlexNIC
- **Virtual Connect Flex-10 technology**
  - Delivered in the Virtual Connect Flex-10 module
  - VC Flex-10 reduces cables and simplifies NIC creation, allocation and management
- **Save money at every turn**
  - Lowest cost solution for 4 or more NICs
  - Lowest power consumption for 6 or more NIC – up to 270w savings per enclosure

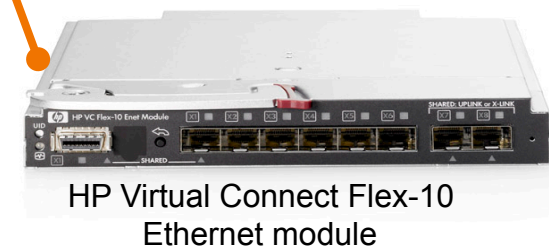

# HP Virtual Connect FC Module



# HP Virtual Connect FC Module

MidPlane 16x 4Gb FC – Connects to one HBA port in each HH blade server bay  
Mgmt Interfaces to Onboard Administrator

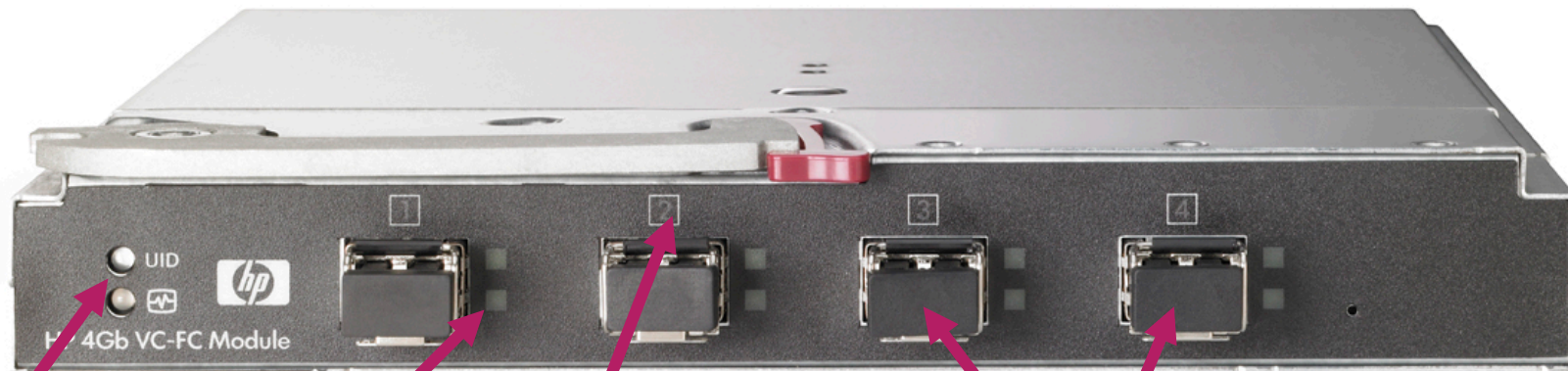

Module LEDs  
*Health and UID*

Port LEDs  
*Link and Activity*

Port Number & Status Indicators  
*Indicates whether a port is configured (green)  
or highlighted (blue).*

4x 1/2/4 Gb FC (SFP)  
*Connects to data center Fibre  
Channel switches.*

Faceplate

Note: VC-FC requires VC-Ethernet  
also installed in same VC domain





# Virtual Connect FC Module helps move the SAN fabric boundary

Standard Blade SAN Configuration Today

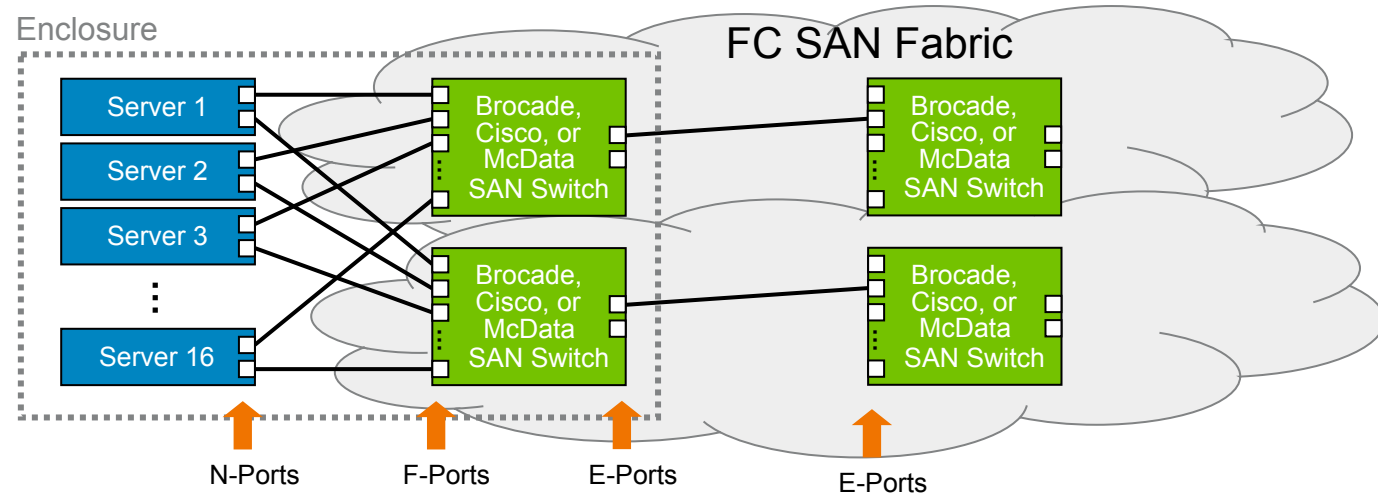

Blade SAN Configuration with Virtual Connect FC

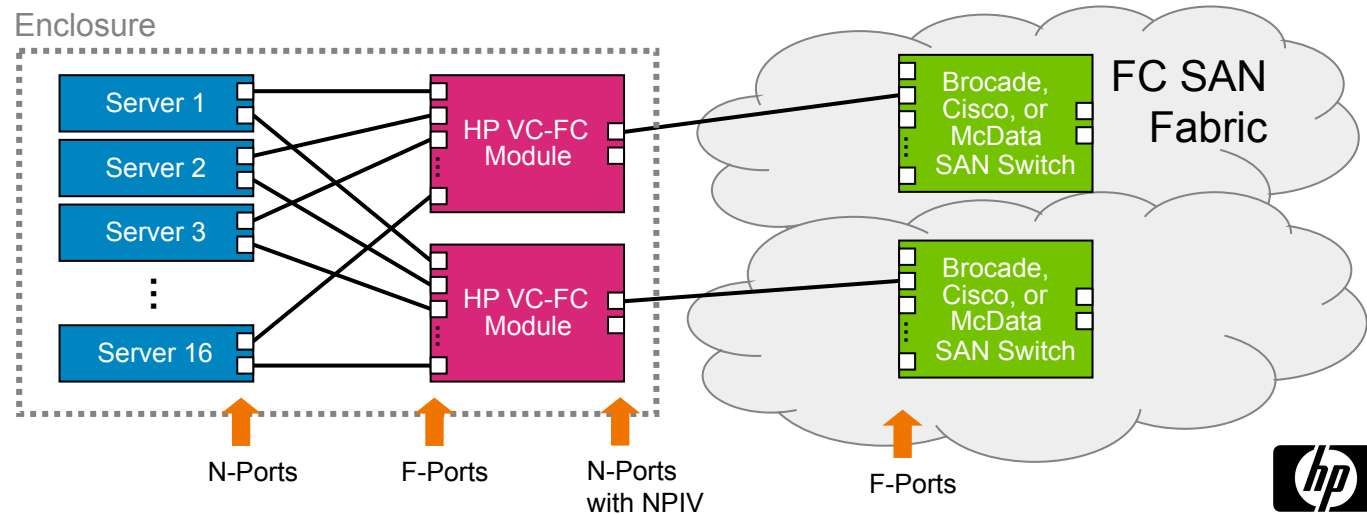

# HP Virtual Connect FC Module uses N\_Port\_ID Virtualization

- Defined by the T11 FC standards
  - FC Device Attach (FC-DA) Specification, Section 4.13
  - FC Link Services (FC-LS) Specification
- “NPIV provides a Fibre Channel facility for assigning multiple N\_Port\_IDs to a single N\_Port, thereby allowing multiple distinguishable entities on the same physical port.”
- Where is it used?
  - When implemented within a FC HBA, allows unique WWNs & IDs for each virtual machine within a server
  - Can be used by a transparent HBA aggregator device (like HP VC-FC module) to reduce cables in a vendor-neutral fashion.

# N\_Port\_ID Virtualization with an HBA aggregator

As used  
by HP VC-FC  
module

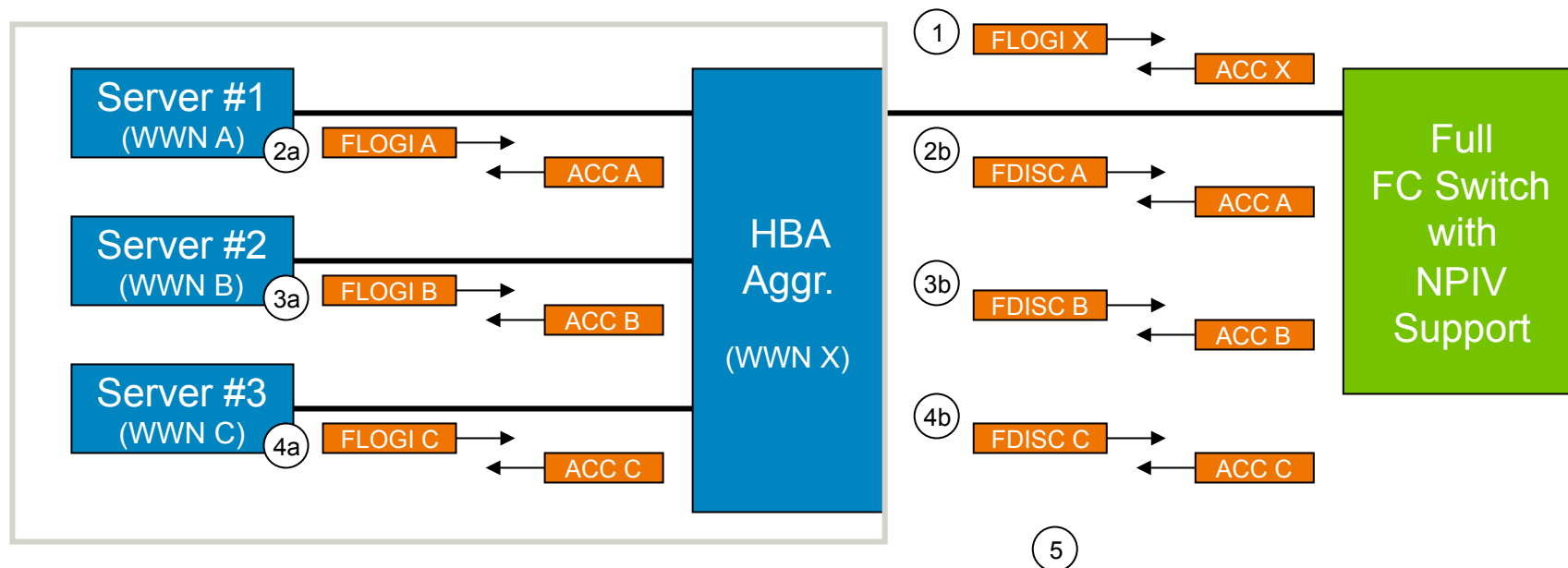

1. Fabric Login using HBA aggregator's WWN (WWN X). Sets up the buffer credits for the overall link. Receives overall Port ID.
- 2-4a Server HBA does normal fabric login with their WWNs.
- 2-4b Server HBA fabric logins translated to 'FDISC'.
5. Traffic for all 4 N-port IDs carried on the same link.

# N\_Port\_ID Virtualization with an HBA aggregator

As used  
by HP VC-FC  
module

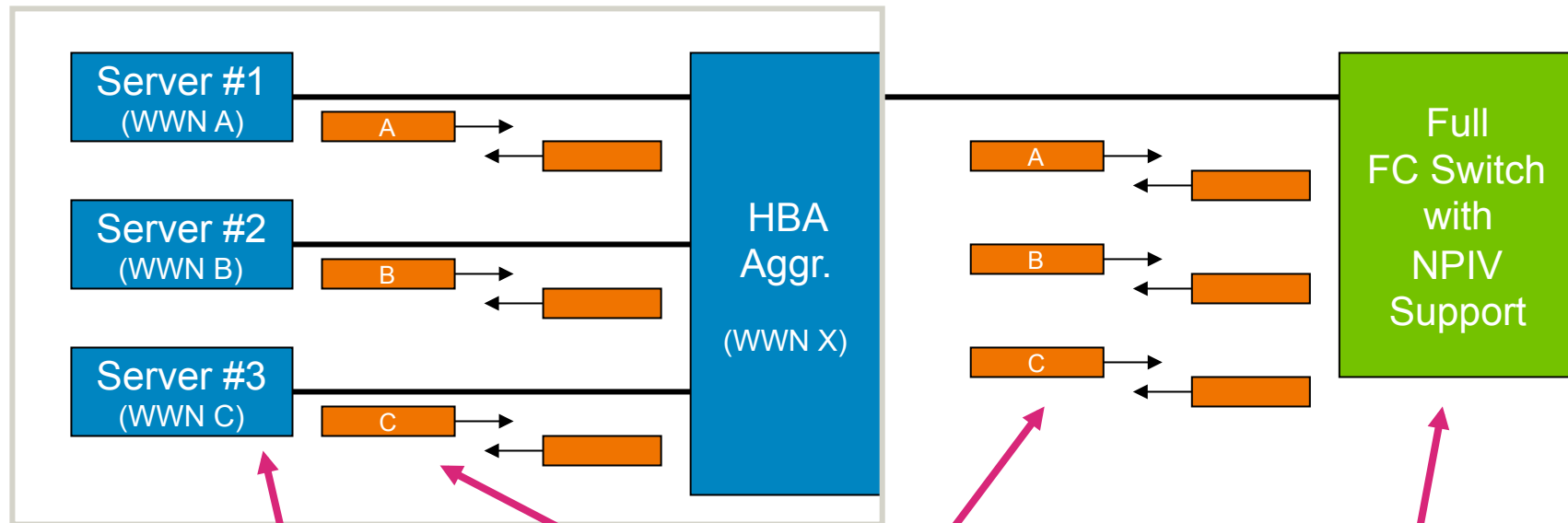

Uses standard FC HBAs  
(Qlogic, Emulex)  
No changes to server OS or  
device drivers

Once server is logged in,  
the FC frames pass  
through unchanged!  
Doesn't interfere with  
server/SAN compatibility.

Works with a wide range  
of Brocade, McData, or  
Cisco FC Switches  
(with recent firmware)

# Partial List of FC Switches with NPIV Support

Manufacturer	Switch Model	Firmware Revision
Brocade	SilkWorm 200E, 3014, 3016, 3250, 3850, 3900, 4012, 4100, 4900, 7500, 24000, 48000	Fabric OS 5.1.0 or later
Cisco	MDS9120, MDS9140, MDS9216, MDS9506, MDS9509, MDS9513	SAN-OS 2.1(2b) or later (Cisco recommends 3.0 or later)
McData	Sphereon 3016, 3032, 3216, 3232, 4300, 4500 Intrepid 6064, 6140, 10000	E/OS 8.0 or later

# Example of FC Switches without NPIV Support

- HP MSA 1x00 switches
- HP EL SAN Switch Series  
(e.g., 2/8 EL, 2/16 EL)

Blade Slot #

Virtual Connect Fibre Channel

Multi-pathing software

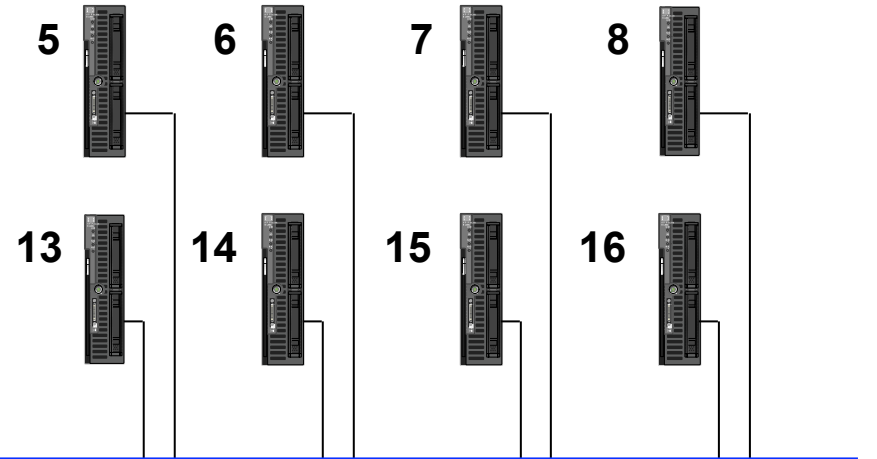
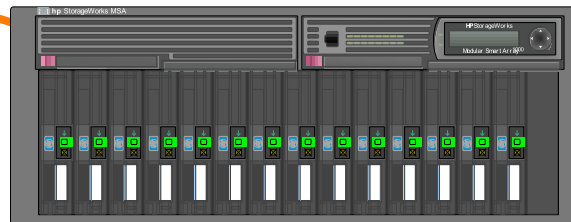
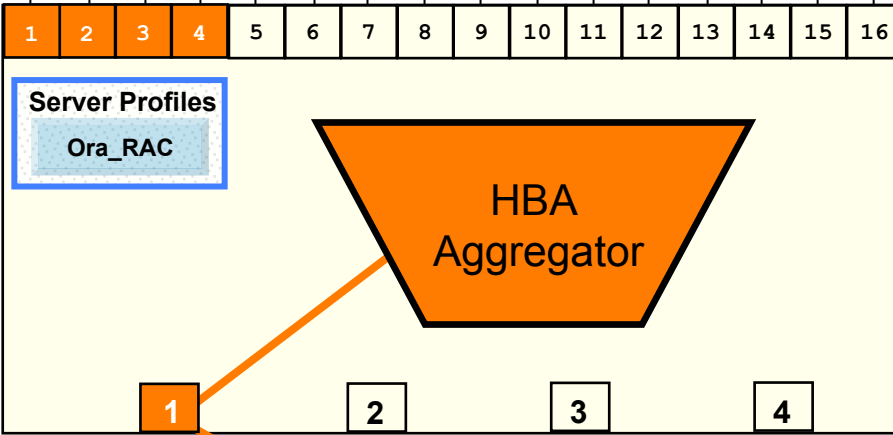

Profiles Define:

- Network Connections
- MAC Addresses
- FC World Wide Names
- FC SAN Connections
- FC Boot Parameters



# VC-FC uplink usage – 1 active uplink



- Uplink 1
- Uplink 2
- Uplink 3
- Uplink 4





# VC-FC uplink usage – 2 active uplinks



- Uplink 1
- Uplink 2
- Uplink 3
- Uplink 4



# VC-FC uplink usage – 3 active uplinks



- Uplink 1
- Uplink 2
- Uplink 3
- Uplink 4



# VC-FC uplink usage – 4 active uplinks



-  Uplink 1
-  Uplink 2
-  Uplink 3
-  Uplink 4



# VC FC New Features Post 1.3x

- Connection to multiple SAN fabrics from one VC module
- Dynamic Login Distribution
- FC Boot parameter support for Integrity Blades and EFI
- Increase in serverside NPIV

# VC FC Multiple SAN Fabric

The screenshot shows the HP Virtual Connect Manager interface. The top navigation bar includes 'Define', 'Configure', 'Tools', and 'Help'. The main content area is titled 'SAN Fabrics' and has two tabs: 'External Connections' and 'Server Connections'. A table lists the configured SAN fabrics with their status, names, login distributions, and port details.

SAN Fabrics	Status	SAN Fabric	Login Distribution	Port Information		Uplink Port Information		
				Status	Connected To	Enclosure	Bay	Port
<input type="checkbox"/>	OK	Production_A	DYNAMIC	OK	4 Gb 51:08:05:03:00:11:30:01	Enclosure1	3	2
				OK	4 Gb 51:08:05:03:00:11:30:01	Enclosure1	3	3
<input type="checkbox"/>	OK	Backup	DYNAMIC	OK	4 Gb 51:08:05:03:00:11:30:11	Enclosure1	3	1
<input type="checkbox"/>	OK	TestSAN	STATIC	OK	4 Gb 51:08:05:03:00:11:30:01	Enclosure1	3	4

Buttons at the bottom include 'Define SAN Fabric', 'Delete', and 'Redistribute Logins'.

# Dynamic vs Static Login Distribution

- Static Login Distribution
  - Pre VC 1.3x FW method of mapping blade HBA port connections to VC FC uplink ports.
  - Not Flexible, cannot change mapping rules
  - Manage uplink login by purposeful placement of blades in the enclosure.
  - Difficult to configure load balancing for some blade server classes, BL870

# Dynamic vs Static Login Distribution

- Dynamic Login Distribution
  - Post VC 1.3x FW Default method of mapping blade HBA port connections to VC FC uplink ports.
  - Provides failover and failback within the VC fabric.
  - Ability to redistribute logins on the VC fabric.
  - No need to worry about server blade placement to VC uplink port connections.
  - Flexibility to create Multiple VC Fabrics and assign specific hosts to uplink ports

# Dynamic vs Static Login Distribution

The screenshot displays the HP Network Configuration Assistant (NCA) interface. On the left, the 'Domain Status' section shows a green checkmark and five status icons (0, 0, 0, 0, 0). Below it, the 'Elements and Events' tree is expanded to 'Interconnect Bays', with 'Bay 5 (HP 4Gb VC-FC Module)' selected.

The main panel shows the configuration for 'Bay 5 (HP 4Gb VC-FC Module)'. It includes a metadata table and two detailed tables: 'Uplink Port Information' and 'Server Port Information'.

Part Number:	409513-B21
Product Name:	HP 4Gb VC-FC Module
Serial Number:	MXK81001XH
Spare Part Number:	410152-001
Manufacturer:	HP
Node WWN:	10:00:00:1E:0B:83:AE:6C

Port	WWN	SAN Fabric	Port Speed	Connector Status	Connected To
1	20:00:00:1E:0B:83:AE:6C	EVA	4 Gb	LOGGED-IN	10:00:00:C0:DD:12:CF:54
2	20:11:00:1E:0B:83:AE:6C	EVA	4 Gb	LOGGED-IN	10:00:00:C0:DD:12:CF:54
3	20:12:00:1E:0B:83:AE:6C		0 Gb	NOT-LOGGED-IN	00:00:00:00:00:00:00
4	20:13:00:1E:0B:83:AE:6C		0 Gb	NOT-LOGGED-IN	00:00:00:00:00:00:00

Port	Server Blade	SAN Fabric	Connected To	Profile	HBA Port	HBA Port Speed	HBA Port Status	HBA WWPN
1	Bay 5	EVA	Uplink Port 1	esx3-2	1	4 Gb	LOGGED-IN	50:06:0B:00:00:C2
2	Bay 5	EVA		windemo3	2	0 Gb	NOT-LOGGED-IN	50:06:0B:00:00:C2
3	Bay 5	EVA	Uplink Port 2	virtualserver	3	4 Gb	LOGGED-IN	50:06:0B:00:00:C2
4	Bay 5				4	0 Gb	NOT-LOGGED-IN	
5	Bay 5	EVA	Uplink Port 1	windemo1	5	4 Gb	LOGGED-IN	50:06:0B:00:00:C2
6	Bay 5				6	0 Gb	NOT-LOGGED-IN	
7	Bay 5				7	0 Gb	NOT-LOGGED-IN	
8	Bay 5	EVA	Uplink Port 2	esx3-3	8	4 Gb	LOGGED-IN	50:06:0B:00:00:C2
9	Bay 5	EVA	Uplink Port 1	esx3-1	9	4 Gb	LOGGED-IN	50:06:0B:00:00:C2
10	Bay 5				10	0 Gb	NOT-LOGGED-IN	
11	Bay 5				11	0 Gb	NOT-LOGGED-IN	
12	Bay 5				12	0 Gb	NOT-LOGGED-IN	
13	Bay 5	EVA	Uplink Port 2	xenserver	13	4 Gb	LOGGED-IN	50:06:0B:00:00:C2
14	Bay 5				14	0 Gb	NOT-LOGGED-IN	
15	Bay 5				15	0 Gb	NOT-LOGGED-IN	
16	Bay 5				16	0 Gb	NOT-LOGGED-IN	



Virtual Connect and  
Integrity blades BL860c



# What is different with Integrity Servers?

- BL860c, BL870c
- Size: BL860c is a full height blade like the BL680c with 4 embedded NICs.
- BL870c is double width. But connectors are only on the right slot. Important for dynamic logging.
- EFI instead of BIOS
  
- What is identical?
- Same FC mezzanines, Qlogic and Emulex

# BIOS vs EFI

Access	special key during the power on sequence	select a special boot entry
User Interface	one unique panel style GUI	panel GUI boot manager cli EFI shell unlimited set of utilities ,cli (nvrambkp) or GUI (EBSU)
Location of data	nvram only	nvram and files in the EFI partition
Setup for boot from SAN	BIOS boot order, IRQ of HBAs Setup of FC HBA	Yet another boot entry. Generated by O/S or manually.

# The concept of boot entries

```
/-----\
|           Boot Menu
| HP-UX Primary Boot: 0/3/0/0/...
| EFI Shell [Built-in]
| Core LAN Port 1
| Core LAN Port 2
| Core LAN Port 3
| Core LAN Port 4
| iLO Virtual Media
| Internal Bootable DVD
| -----
| Boot Configuration
| System Configuration
| Security Configuration
| -----
\-----/
```

- Each boot entry contains
  - A full device path
  - A file path
  - O/S option
- Easy choice between
  - SAN
  - local disk
  - DVD
  - Network
  - EFI Shell

# VC profile for Integrity server

- Integrity specific field “EFI partition”

Profile Name	Status	Server Serial Number	Server UUID
ipinel1	OK 	/CX0001H07	a778f9c5-b497-4646-80e9-ac90ad358a85

Remove EFI partition attached to profile

- Means that the Boot entries of the NVRAM are saved in the VC profile
- Triggered by setting a primary boot from SAN:

## FC SAN Connections (Physical ports)

Port	Connected To	FC SAN Name	Status
1	Bay 3	eva	OK
2	Bay 4	Unassigned	OK

Show Fibre Channel Boot Parameters

Port	SAN Boot ?	Target Port Name (WWPN) ?	LUN ?
1	Primary	50:00:1F:E1:00:15:13:78	1
2	Use BIOS/EFI		



### Target Port Name

The world-wide port name of the controller interface on the Fibre Channel storage target. The port name is a 64-bit identifier and must be entered as NN:NN:NN:NN:NN:NN:NN:NN, where 'N' is a hexadecimal value (0-F).

# The process step by step

## Proliant Integrity

- Create a VC profile with valid SAN and LAN ports and the boot parameters
  - The VC sets automatically the BIOS boot order and the FC mezzanine setup
  - Present a SAN LUN to the WWID of the SAN port
  - Install the O/S by virtual media or RDP
- Create a VC profile with valid SAN and LAN ports
  - Do not configure boot parameters yet
  - Present a SAN LUN to the WWID of the SAN port
  - Install the O/S by virtual media or Ignite-UX or RDP
  - During installation select the SAN lun as system disk
  - The installation creates automatically the primary boot entry from SAN
  - When installation is finished, power of the blade
  - Edit the VC profile, add the boot parameters
  - Power on the blade
  - At FC card detection, the “EFI partition” icon appears.
  - All boot entries have been captured and stored in the profile



# Assigning the profile to another blade

## Proliant Integrity

- VC edits the BIOS boot order
- VC makes the FC mezzanine setup
- VC updates the nvram of the new blade
- VC writes the stored boot entries into the nvram of the new blade
- Caution:
- It does it for **all** boot entries

Before creating a profile with boot from SAN, clean up the other boot entries.

# What about VCEM?

- Needs version 1.34 of VCM and 1.2x of VCEM
- The “EFI partition” does not appear on the GUI
- No way to remove it
- Prepare the boot from SAN as for VCM
- Setup the boot parameter, power on the blade
- It is possible to check with VCM
- Once a valid “EFI partition” is created, totally transparent, same usage as Proliant blades



# HP Virtual Connect Enterprise Manager



# Virtual Connect Enterprise Manager

Builds on and extends Virtual Connect technology and value

Virtual Connect Enterprise Manager

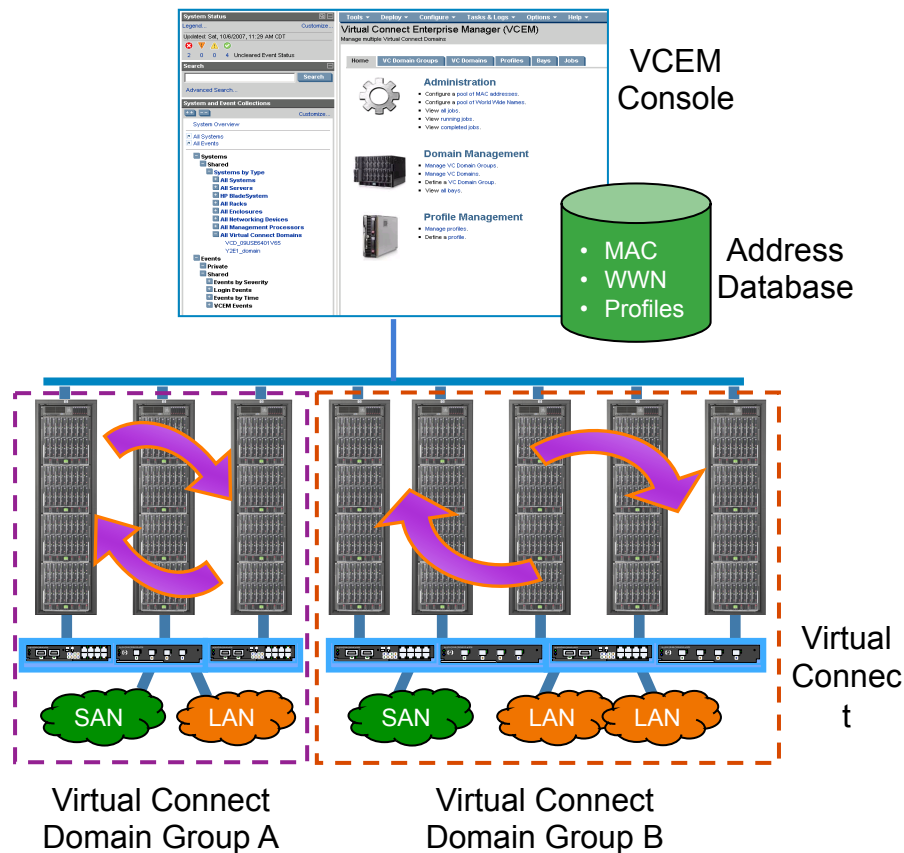

- Manage 100 Virtual Connect domains via a single console
- Central database prevents LAN/SAN address conflicts
- Domain group baselines simplify configuration and changes for multiple VC domains
- Server profile movement between enclosures extends administrator reach across the datacenter
- Streamlines management
- Reduces repetitive tasks and configuration errors
- Licensed per blade enclosure

# Ideal VCEM environments

- Datacenters with multiple enclosures
  - Simplify infrastructure management across the datacenter
  - Increase IT consistency, productivity and availability
  - Respond faster to business needs
  - Reduce time, costs and risks

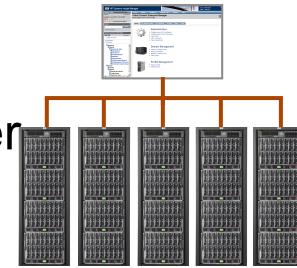

- BladeSystem environments on multiple sites
  - Central management to simplify operations, reduce travel, response times and costs

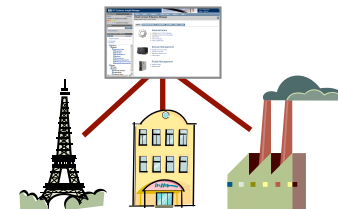

- Dynamic environments
  - Add, modify and move server resources to meet changing workload and business demands

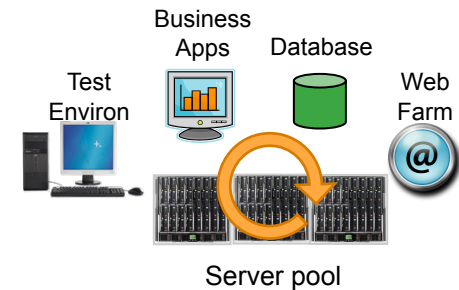

# Virtual Connect Domain Grouping

## Key features

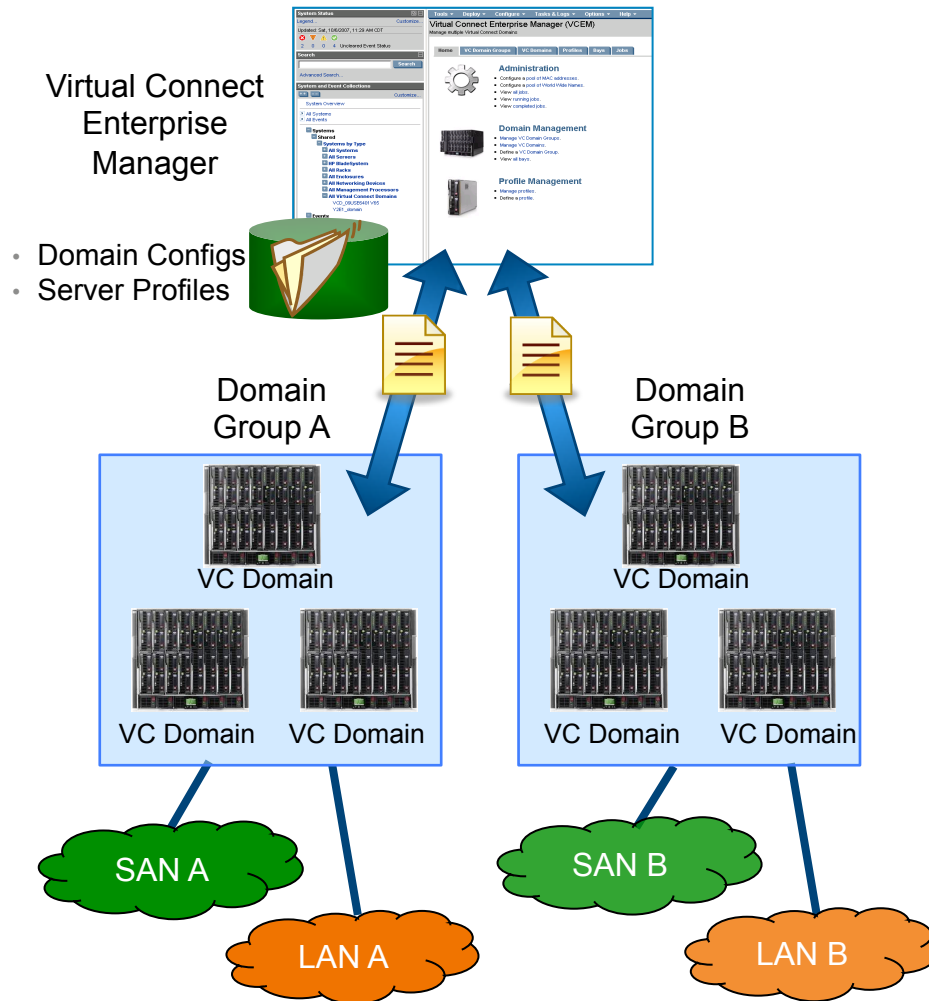

- Baselines simplify config & change for multiple Virtual Connect domains
- Group members must share the same uplinks to LANs/SANs
- Enforce changes quickly across all domains in a group by modifying the group profile
- Add new/bare metal enclosures and configure VC domains quickly by assigning to a domain group
- Increase datacenter consistency
- Reduce complexity, repetitive tasks config errors and conflicts

# VCEM server profile movement

## Key features

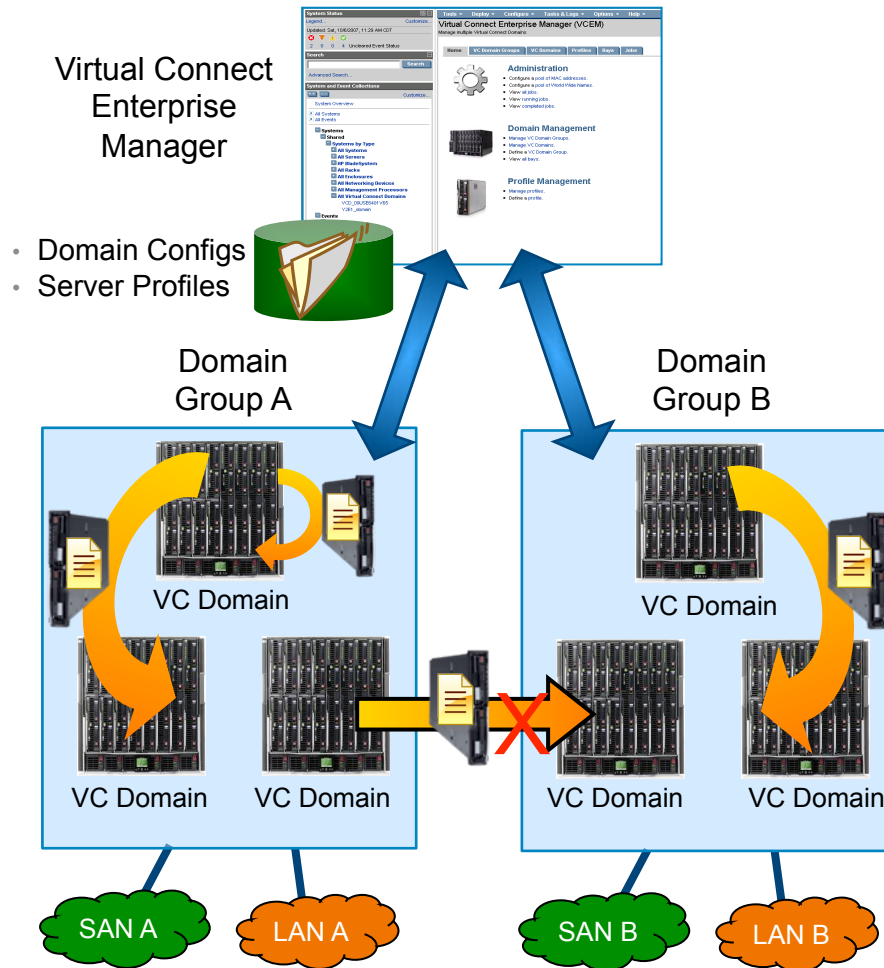

- Move blade server connection profiles between enclosures within a Virtual Connect Domain Group
  - No movement between groups
- Virtual Connect maintains consistent LAN/SAN connections
  - Network associations move with the server connection profile
- Manual/scripted profile moves
- Audit trail provides full history
- Best response times and least administration in boot from SAN environment
  - Local boot configuration typically requires additional administration

# VCEM server recovery example

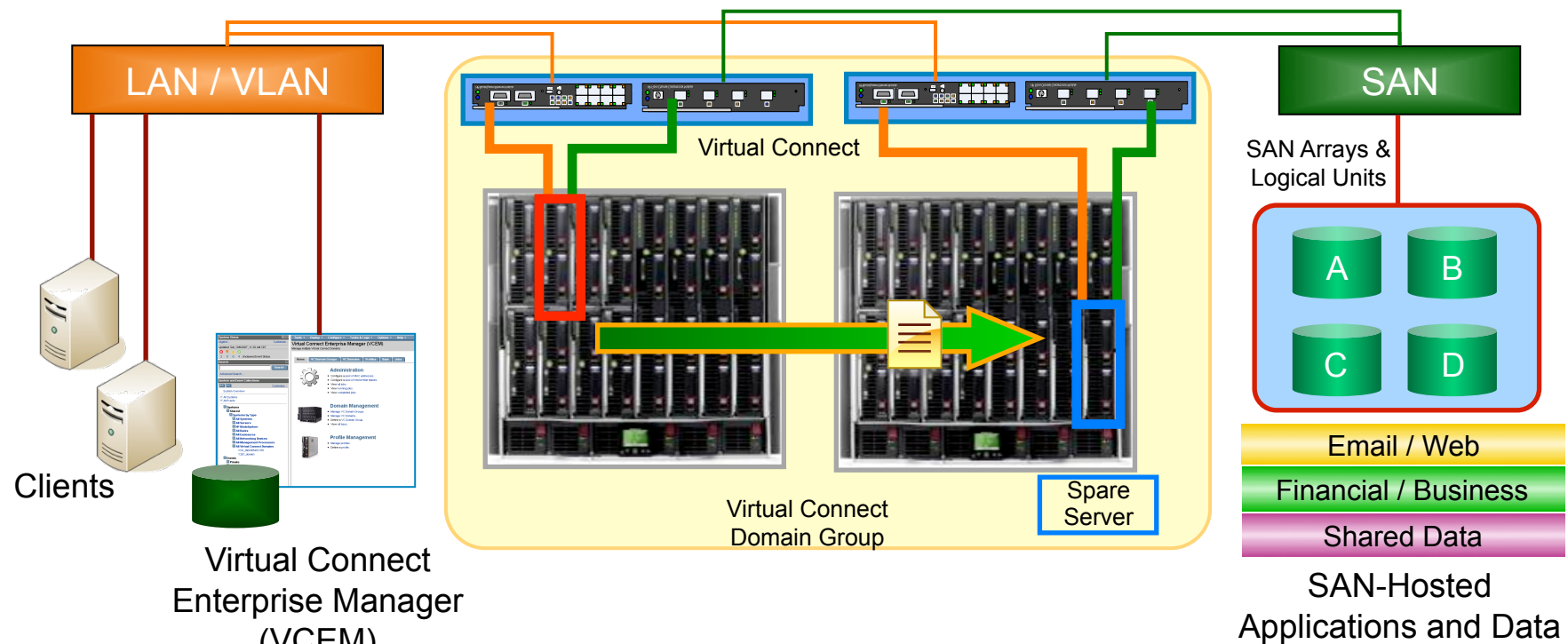

## Infrastructure Overview

- Virtual Connect domain group with 2 BladeSystem enclosures; LAN and SAN connections managed with Virtual Connect
- represents a production server
- represents a spare blade server

## Operations

- Production server  reports problem or requires removal from production environment
- Power off production server
- Use VCEM to move server profile /workload to spare
- Power on spare server  as replacement production server
- Server connection profile automatically restores production LAN & SAN assignments

# VCEM blade server failover

## Overview

Virtual Connect Domain Group

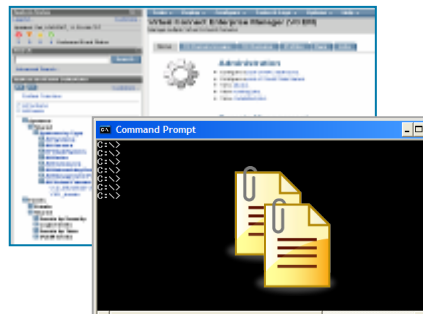
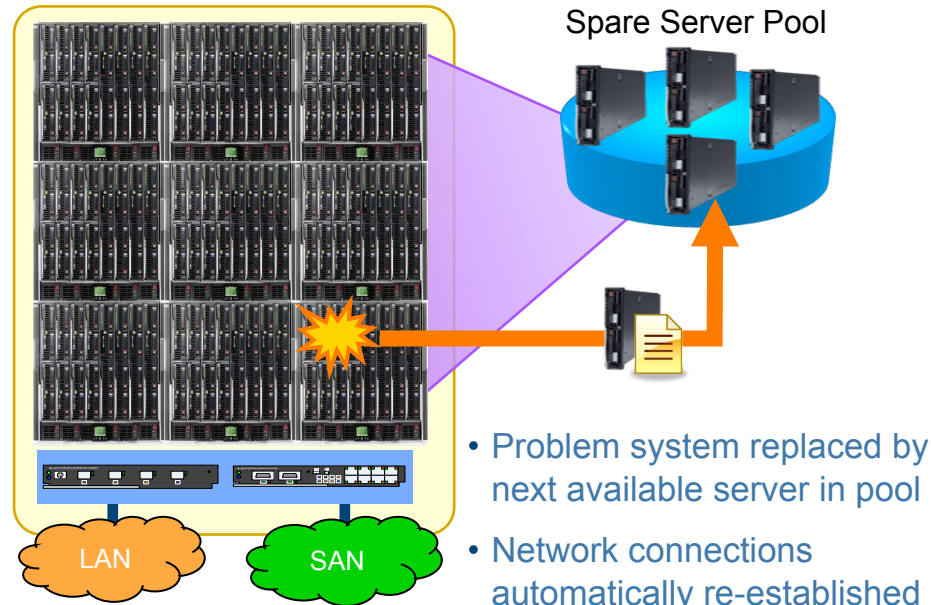

- Failover automatically or manually from VCEM GUI
- Failover automatically or manually via command line

- Customer defined spare server pool covers all servers in a Virtual Connect Domain Group
- Automatically replaces problem server with the same model and migrates server connection profile
- Virtual Connect re-establishes LAN and SAN connections
- Flexible options to initiate failover:
  - Manually select replacement server and move profile (delivered in VCEM v1.0)
  - Single task in GUI automatically selects replacement and moves profile (v1.1)
  - CLI script automatically selects server replacement and moves profile (v1.1)
  - Useable sample scripts included 

# VCEM user interface

- VCEM leverages selected HP SIM services, Virtual Connect Manager and Onboard Administrator “under the covers” – (discovery, monitoring etc)
- VCEM presents a dedicated homepage
  - Focuses on Virtual Connect domain management and profile movement
  - Not a general purpose management console for servers, storage etc
  - Includes linkage to Onboard Administrator, BladeSystem Integrated Manager

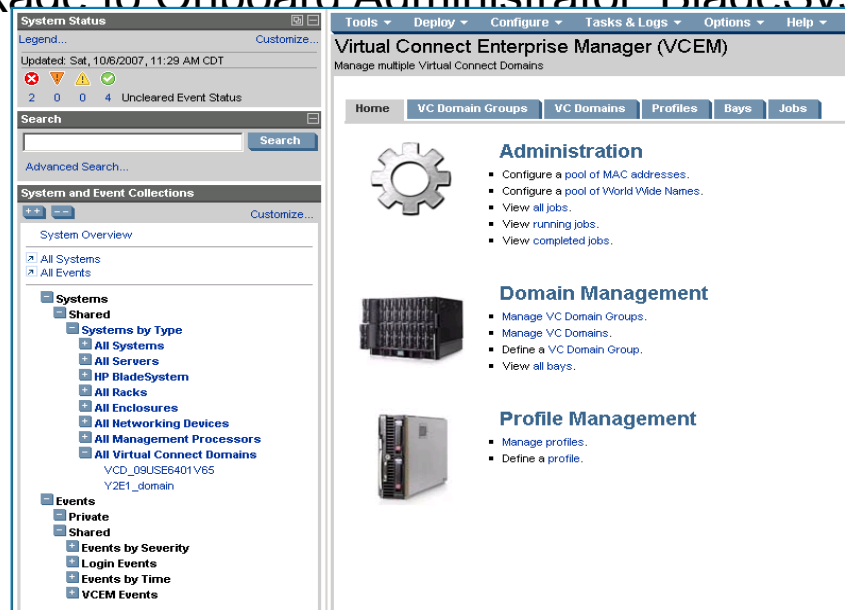



# VCEM licensing

- Introduces licensing by c-Class enclosure – 1 license per enclosure
  - Permanent license covers all enclosure bays for the life of the enclosure
  - Designed to provide broad functional readiness and exceptional value
  - Supports multiple server models and generations
  - Add, change, upgrade servers without renewing VCEM license
- License keys
  - Licenses for c7000 and c3000 enclosures (single and multiple options)
  - Evaluation licenses (90 days) available via Insight Control trial download  
[www.hp.com/go/tryinsightcontrol](http://www.hp.com/go/tryinsightcontrol)

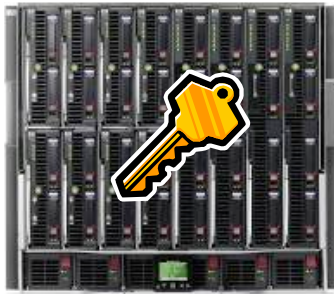

- Single license per enclosure
- Covers all bays in enclosure for the life of the enclosure

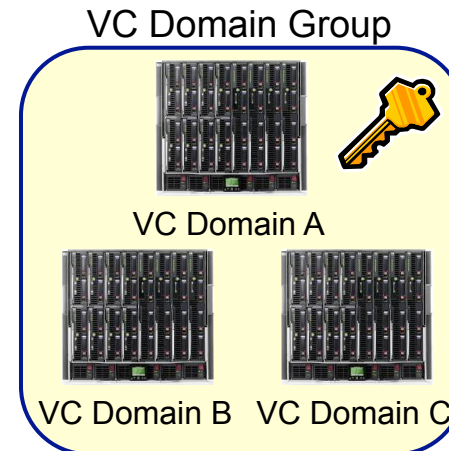

- All enclosures in a VC domain group must be covered by a single or group VCEM license key
- In this example a multiple quantity license covers all enclosures in the group

# VCEM roadmap

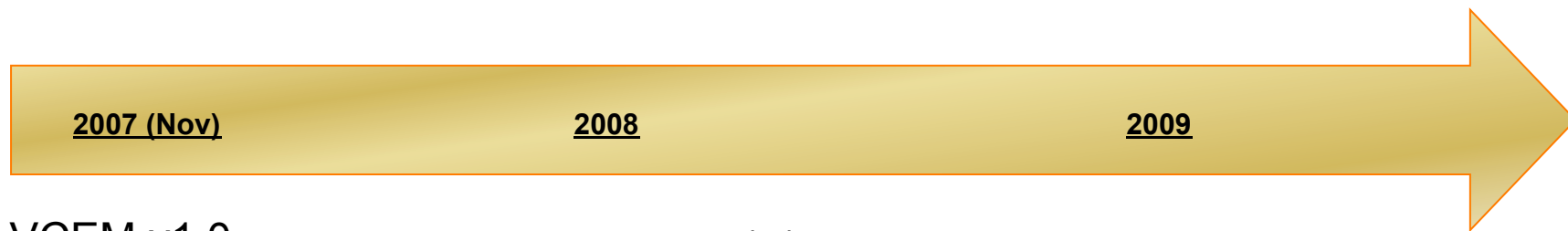

## VCEM v1.0

- Single console for 100 enclosures
- Central administration for 65,000 LAN/SAN addresses
- Virtual Connect domain grouping
- Standalone installation (Windows Server 2003 host)
- HP BladeSystem ProLiant blades

## v1.1

- Automated failover to spare server pool
- Command line interface
- Plug-in to HP Systems Insight Manager v5.2 and standalone options
- HP BladeSystem Integrity blades (limited movement functionality)

## v1.2

- Extended Integrity blade movement
- Additional failover / automation
- Manage multi-enclosure domains
- Virtual serial numbers
- Service level integration

# Q&A



i n v e n t